

General Description:

HM0565, the silicon N-channel Enhanced VDMOSFETs, is obtained by the self-aligned planar Technology which reduce the conduction loss, improve switching performance and enhance the avalanche energy. The transistor can be used in various power switching circuit for system miniaturization and higher efficiency. The package form is SOT23-3L, which accords with the RoHS standard.

Features:

- **Fast Switching**
- **Low ON Resistance**($R_{ds(on)} \leq 10.5\Omega$)
- **Low Gate Charge** (Typical Data:6.0nC)
- **Low Reverse transfer capacitances**(Typical:4pF)
- **100% Single Pulse avalanche energy Test**

Applications:

Power switch circuit of adaptor and charger.

Absolute (Tc= 25°C unless otherwise specified):

Symbol	Parameter	Rating	Units
V _{DSS}	Drain-to-Source Voltage	650	V
I _D	Continuous Drain Current	0.5	A
	Continuous Drain Current T _C = 100 °C	0.35	A
I _{DM} ^{a1}	Pulsed Drain Current	2.0	A
V _{GS}	Gate-to-Source Voltage	±30	V
E _{AS} ^{a2}	Single Pulse Avalanche Energy	70	mJ
E _{AR} ^{a1}	Avalanche Energy ,Repetitive	6	mJ
I _{AR} ^{a1}	Avalanche Current	1.1	A
dv/dt ^{a3}	Peak Diode Recovery dv/dt	5.0	V/ns
P _D	Power Dissipation	3	W
	Derating Factor above 25°C	0.024	W/°C
T _J , T _{stg}	Operating Junction and Storage Temperature Range	150, -55 to 150	°C
T _L	Maximum Temperature for Soldering	300	°C

V _{DSS}	650	V
I _D	0.5	A
P _D (T _C =25°C)	3	W
R _{DS(ON)Typ}	9	Ω

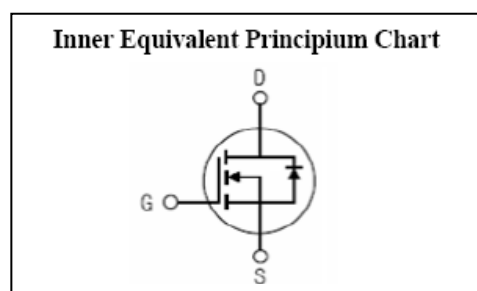
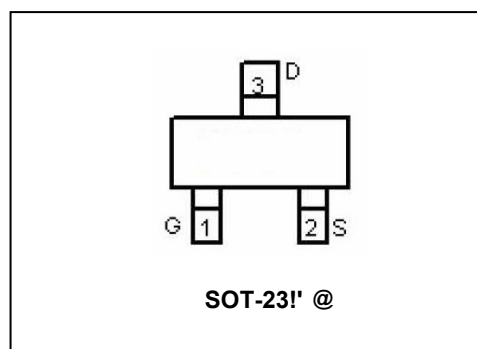

Electrical Characteristics (Tc= 25°C unless otherwise specified):

OFF Characteristics						
Symbol	Parameter	Test Conditions	Rating			Units
			Min.	Typ.	Max.	
V _{DSS}	Drain to Source Breakdown Voltage	V _{GS} =0V, I _D =250μA	650	--	--	V
Δ BV _{DSS} / Δ T _J	Bvdss Temperature Coefficient	ID=250uA, Reference 25°C	--	0.71	--	V/°C
I _{DSS}	Drain to Source Leakage Current	V _{DS} = 600V, V _{GS} = 0V, T _a = 25°C	--	--	25	μA
		V _{DS} =480V, V _{GS} = 0V, T _a = 125°C	--	--	250	
I _{GSS(F)}	Gate to Source Forward Leakage	V _{GS} =+30V	--	--	100	nA
I _{GSS(R)}	Gate to Source Reverse Leakage	V _{GS} =-30V	--	--	-100	nA

ON Characteristics						
Symbol	Parameter	Test Conditions	Rating			Units
			Min.	Typ.	Max.	
R _{DS(ON)}	Drain-to-Source On-Resistance	V _{GS} =10V, I _D =0.5A	--	9	30	Ω
V _{GS(TH)}	Gate Threshold Voltage	V _{DS} = V _{GS} , I _D = 250μA	2.0		4.0	V
Pulse width tp ≤ 380μs, δ ≤ 2%						

Dynamic Characteristics						
Symbol	Parameter	Test Conditions	Rating			Units
			Min.	Typ.	Max.	
g _{fs}	Forward Transconductance	V _{DS} =15V, I _D =0.5A	--	0.70	--	S
C _{iSS}	Input Capacitance	V _{GS} = 0V V _{DS} = 25V f = 1.0MHz	--	150	--	pF
C _{oss}	Output Capacitance		--	25	--	
C _{rSS}	Reverse Transfer Capacitance		--	4	--	

Resistive Switching Characteristics						
Symbol	Parameter	Test Conditions	Rating			Units
			Min.	Typ.	Max.	
t _{d(ON)}	Turn-on Delay Time	I _D =0.5A V _{DD} = 300V V _{GS} = 10V R _G = 25Ω	--	23	--	ns
t _r	Rise Time		--	27	--	
t _{d(OFF)}	Turn-Off Delay Time		--	12	--	
t _f	Fall Time		--	27	--	
Q _g	Total Gate Charge	I _D =0.5A V _{DD} =480V V _{GS} = 10V	--	6.0		nC
Q _{gs}	Gate to Source Charge		--	1.1		
Q _{gd}	Gate to Drain (“Miller”)Charge		--	3.5		

Source-Drain Diode Characteristics						
Symbol	Parameter	Test Conditions	Rating			Units
			Min.	Typ.	Max.	
I_S	Continuous Source Current (Body Diode)		--	--	0.5	A
I_{SM}	Maximum Pulsed Current (Body Diode)		--	--	2.0	A
V_{SD}	Diode Forward Voltage	$I_S=0.5A, V_{GS}=0V$	--	--	1.5	V
t_{rr}	Reverse Recovery Time	$I_S=0.5A, T_J = 25^\circ C$ $di_f/dt=100A/us,$ $V_{GS}=0V$	--	140		ns
Q_{rr}	Reverse Recovery Charge		--	224		nC
I_{RRM}	Reverse Recovery Current		--	3.2		A
Pulse width $t_p \leq 380\mu s, \delta \leq 2\%$						

Symbol	Parameter	Typ.	Units
$R_{\theta JC}$	Junction-to-Case	41.7	$^\circ C/W$
$R_{\theta JA}$	Junction-to-Ambient	200	$^\circ C/W$

^{a1}: Repetitive rating; pulse width limited by maximum junction temperature

^{a2}: $L=10.0mH, I_D=3.7A, Start T_J=25^\circ C$

^{a3}: $I_{SD}=1.2A, di/dt \leq 100A/us, V_{DD} \leq BV_{DS}, Start T_J=25^\circ C$

Characteristics Curve:

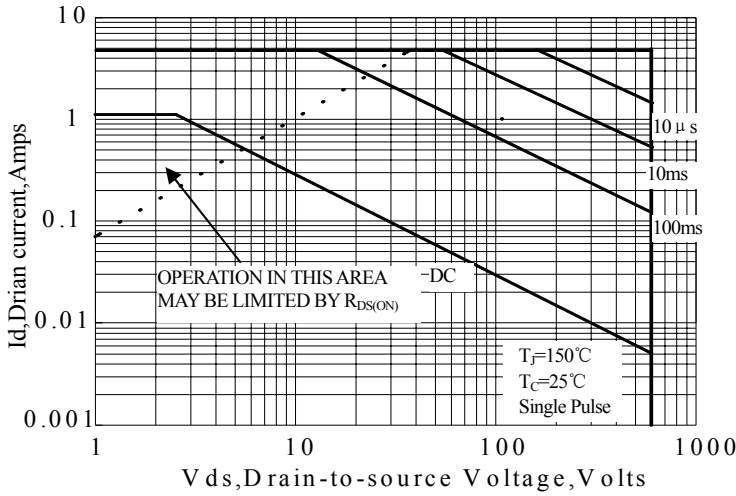

Figure 1 Maximum Forward Bias Safe Operating Area

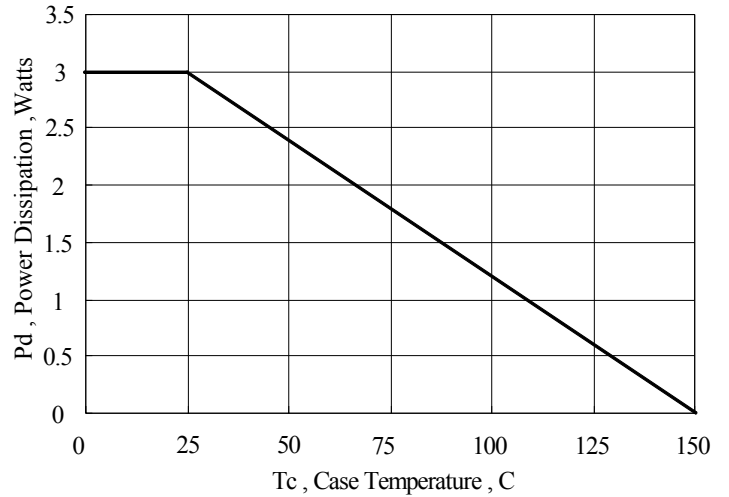

Figure 2 Maximum Power Dissipation vs Case Temperature

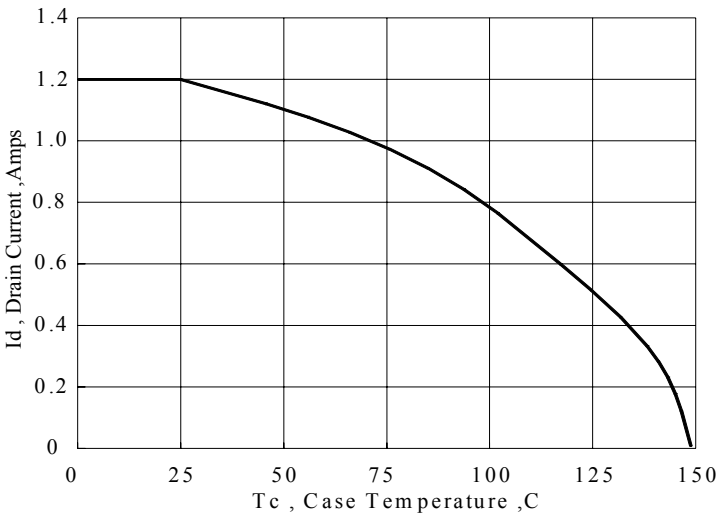

Figure 3 Maximum Continuous Drain Current vs Case Temperature

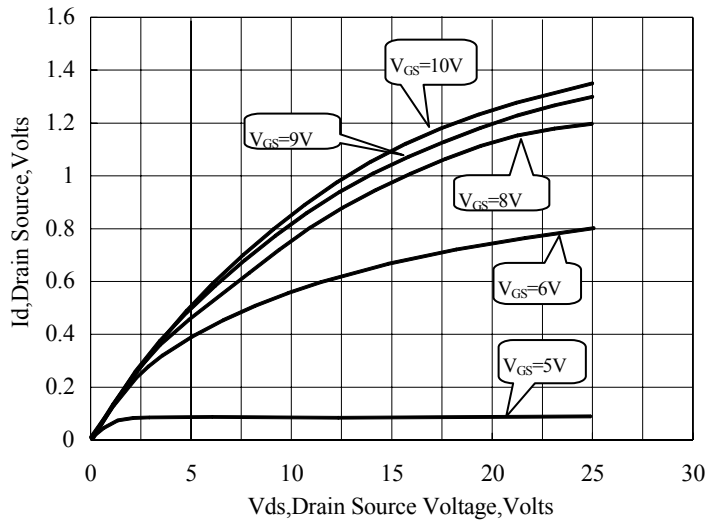

Figure 4 Typical Output Characteristics

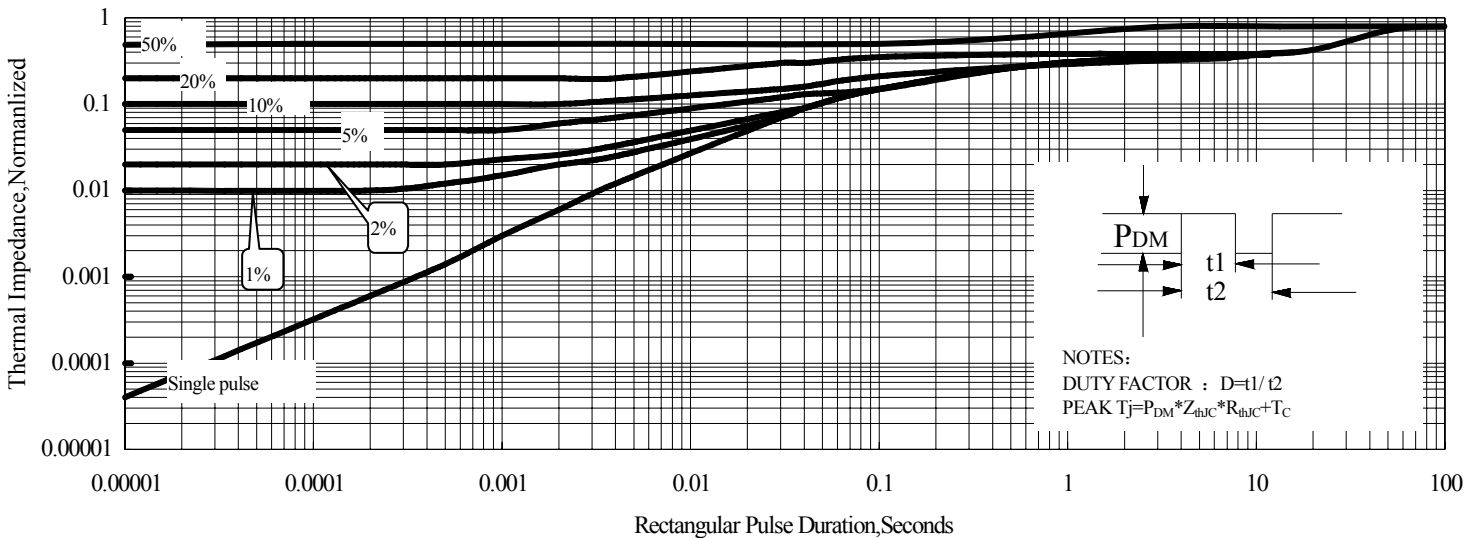

Figure 5 Maximum Effective Thermal Impedance, Junction to Case

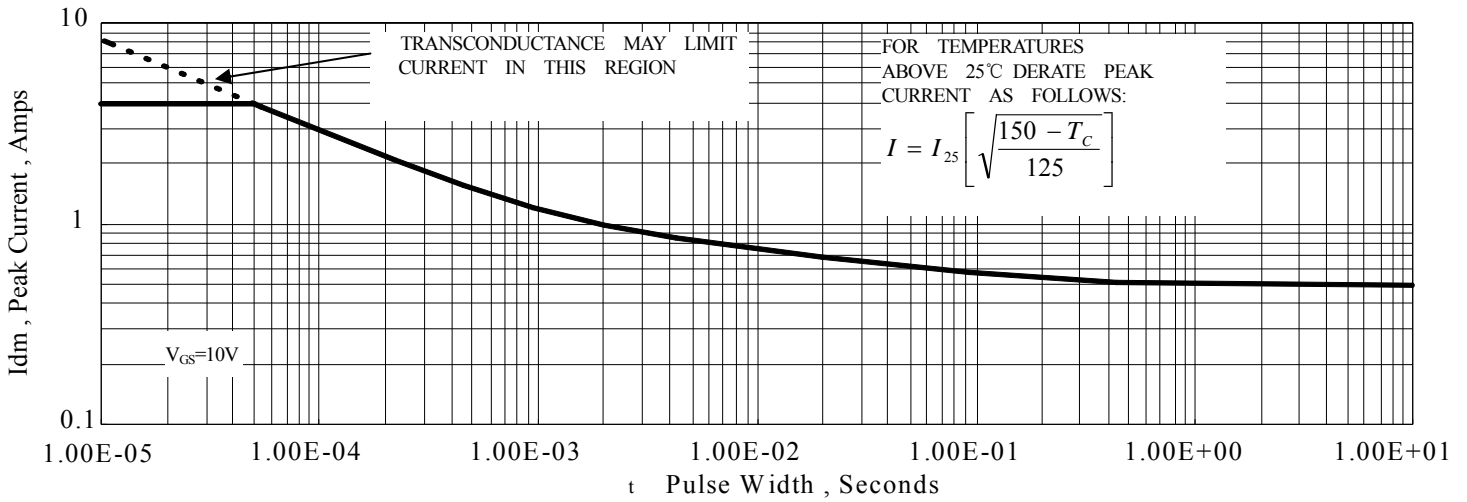

Figure 6 Maximum Peak Current Capability

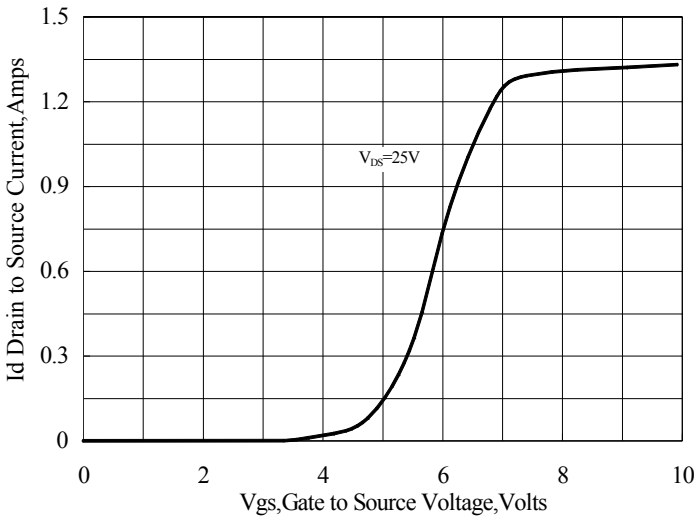

Figure 7 Typical Transfer Characteristics

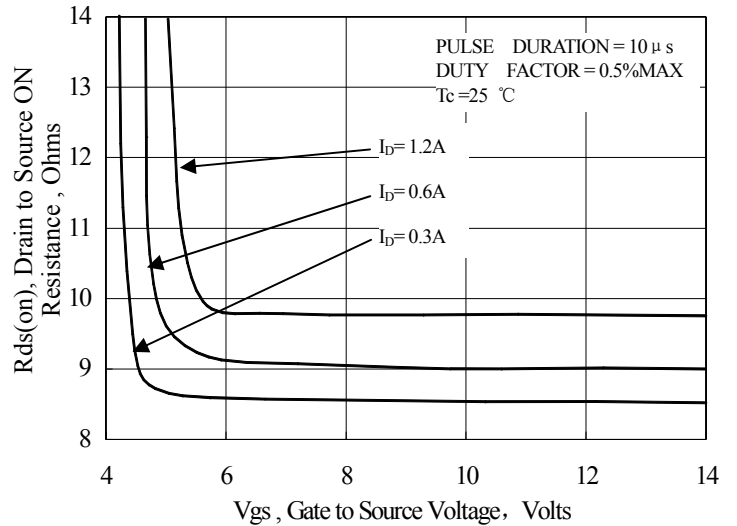

Figure 8 Typical Drain to Source ON Resistance vs Gate Voltage and Drain Current

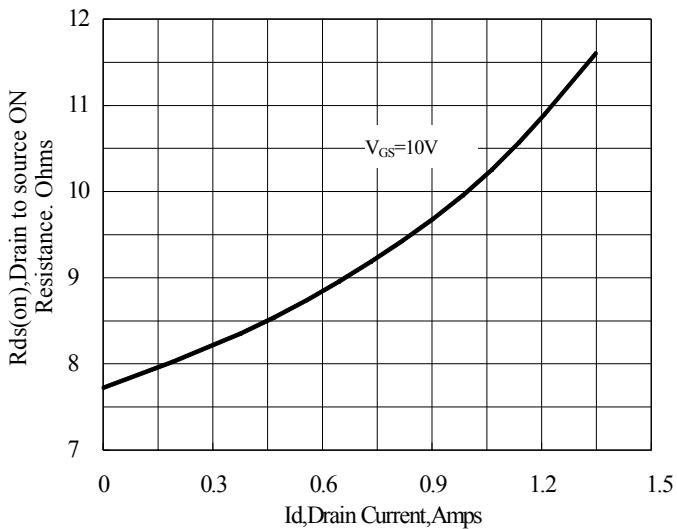

Figure 9 Typical Drain to Source ON Resistance vs Drain Current

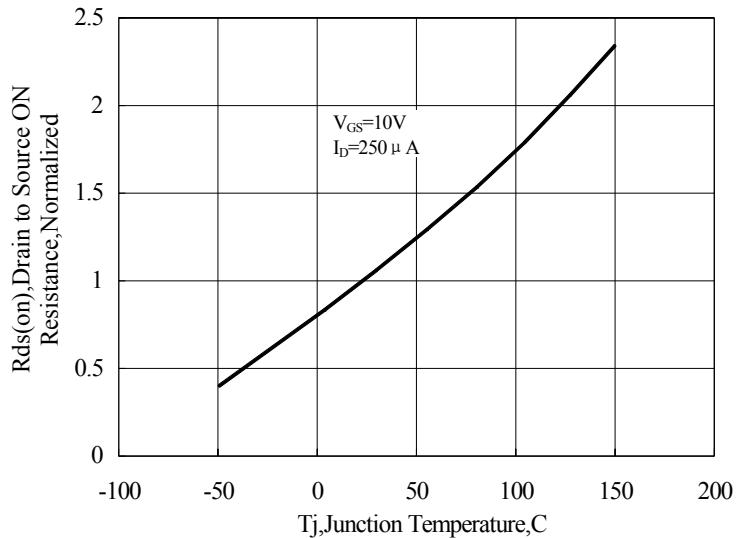

Figure 10 Typical Drain to Source on Resistance vs Junction Temperature

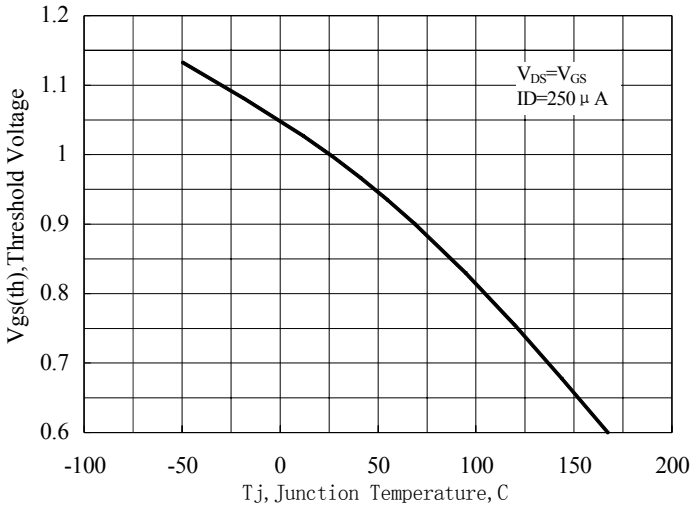

Figure 11 Typical Threshold Voltage vs Junction Temperature

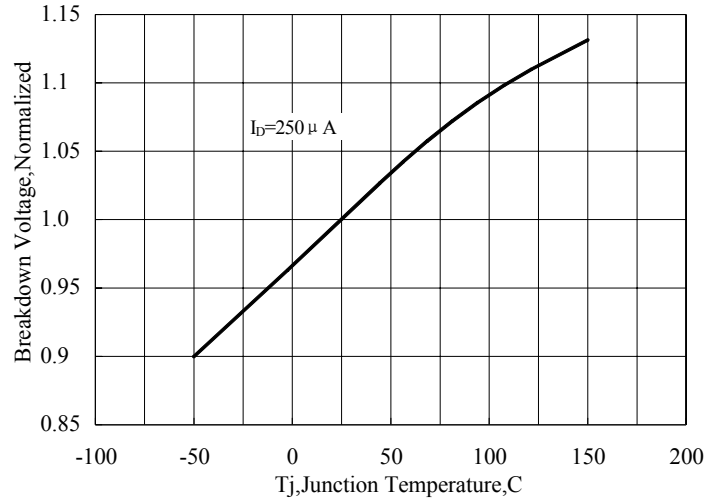

Figure 12 Typical Breakdown Voltage vs Junction Temperature

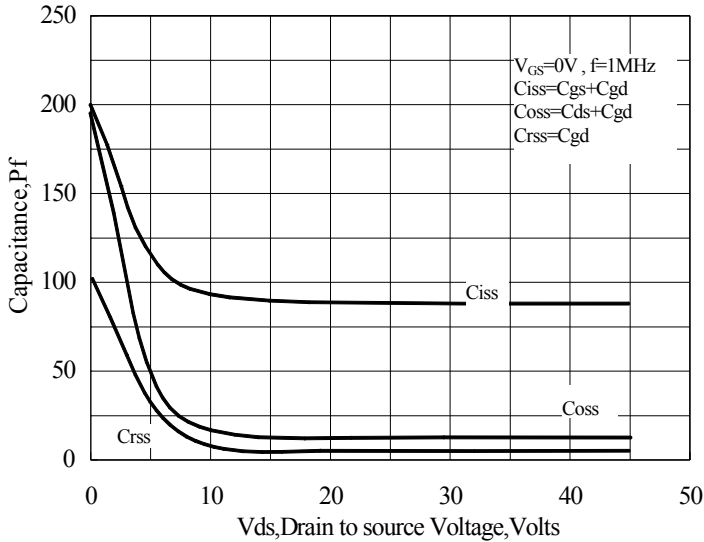

Figure 13 Typical Capacitance vs Drain to Source Voltage

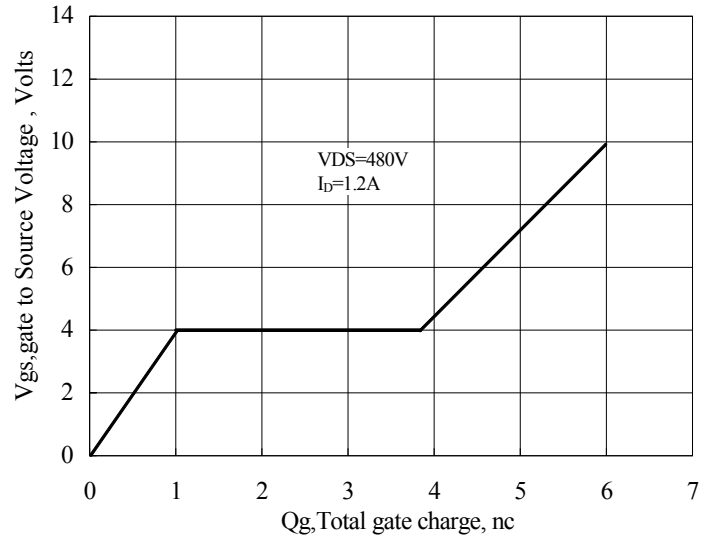

Figure 14 Typical Gate Charge vs Gate to Source Voltage

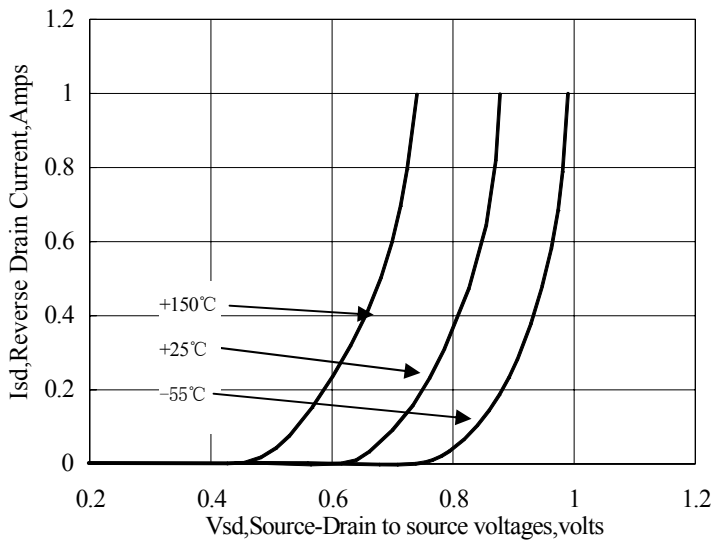

Figure 15 Typical Body Diode Transfer Characteristics

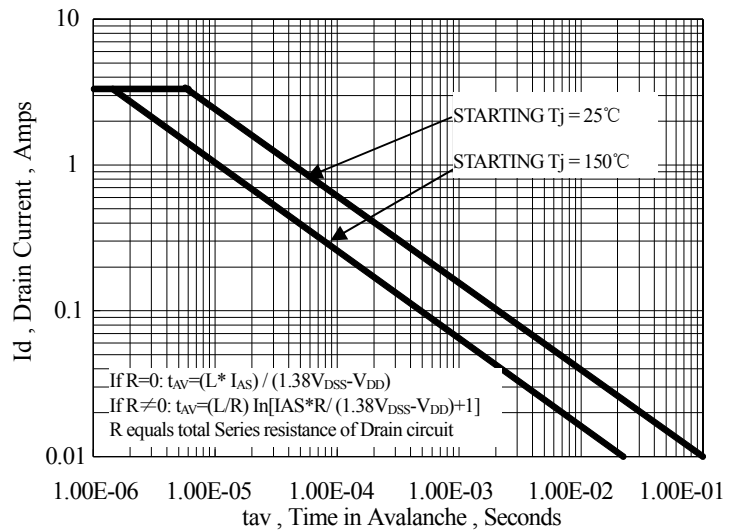
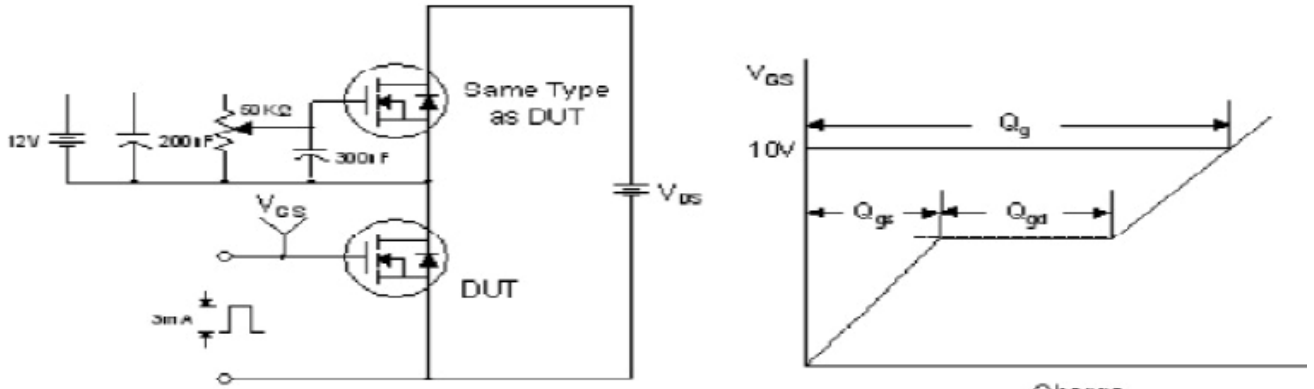
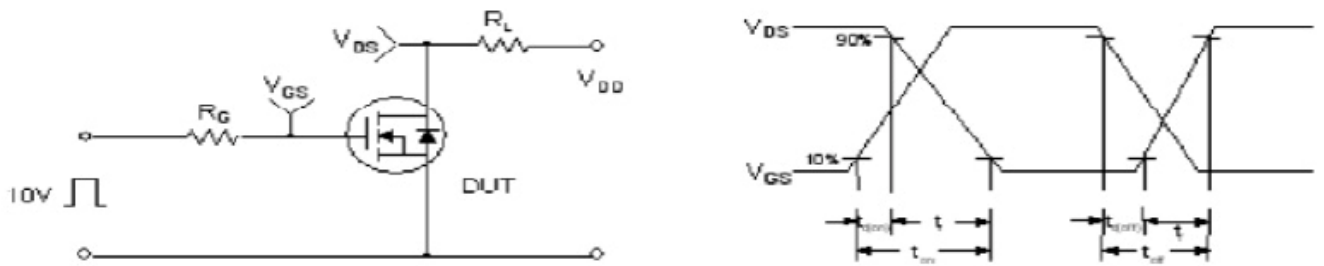

Figure 16 Unclamped Inductive Switching Capability

TestCircuitandWaveform



Gate Charge Test Circuit and Waveform



Resistive Switching Test Circuit and Waveform

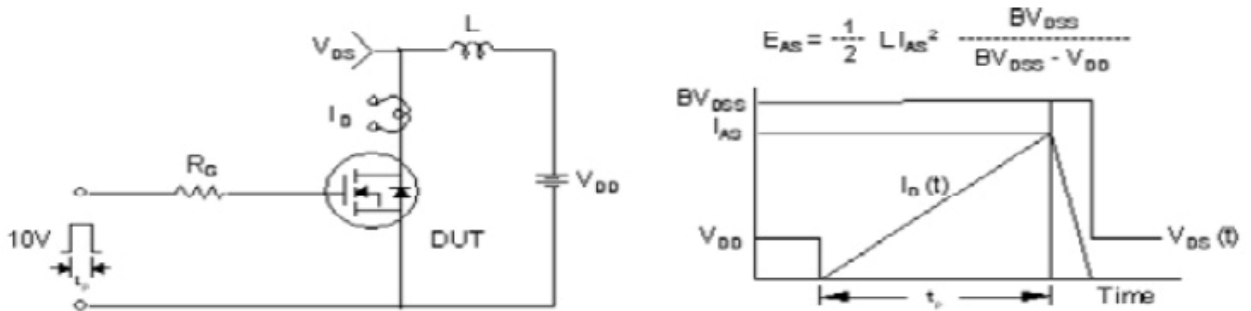

Unclamped Inductive Switching Test Circuit and Waveform

$$E_{AS} = \frac{1}{2} L I_{AS}^2 \frac{BV_{DSS}}{BV_{DSS} - V_{D0}}$$

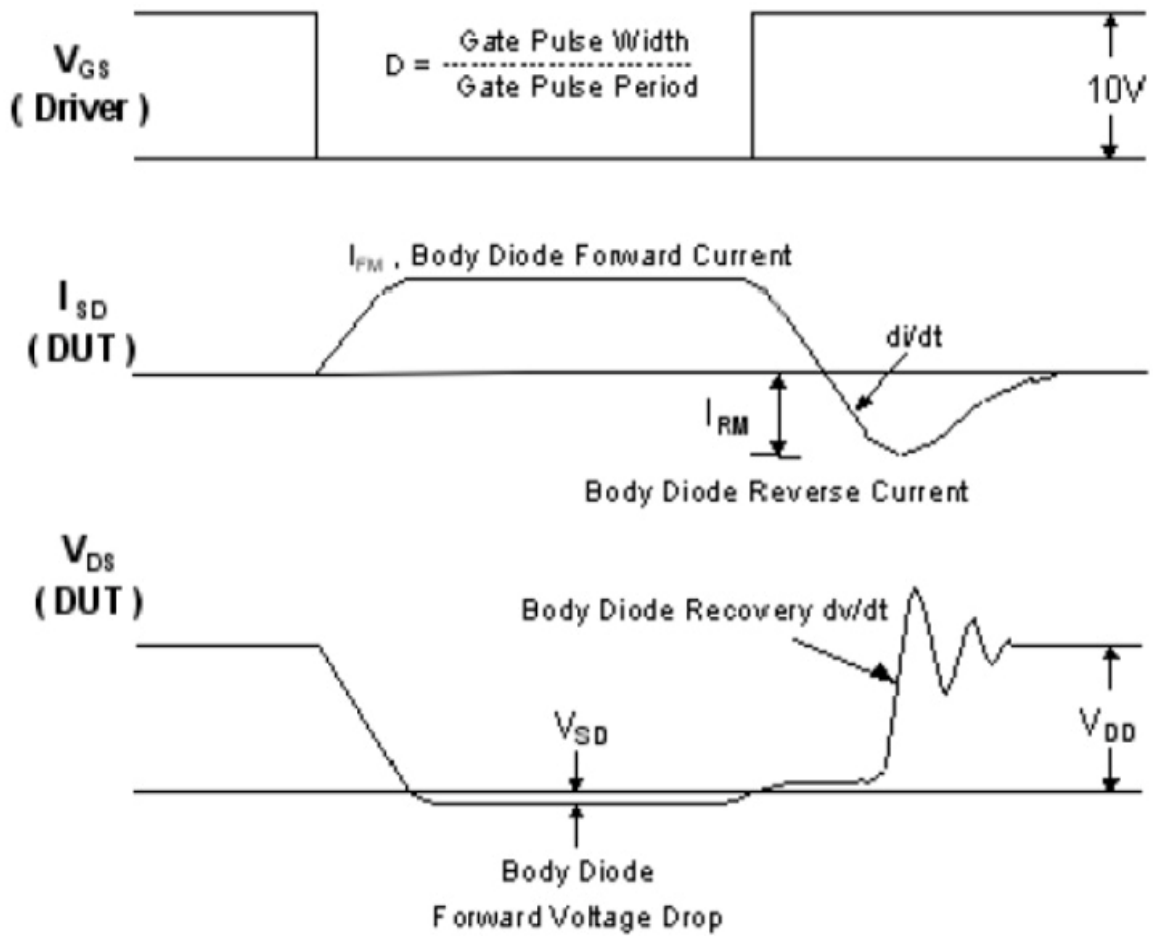
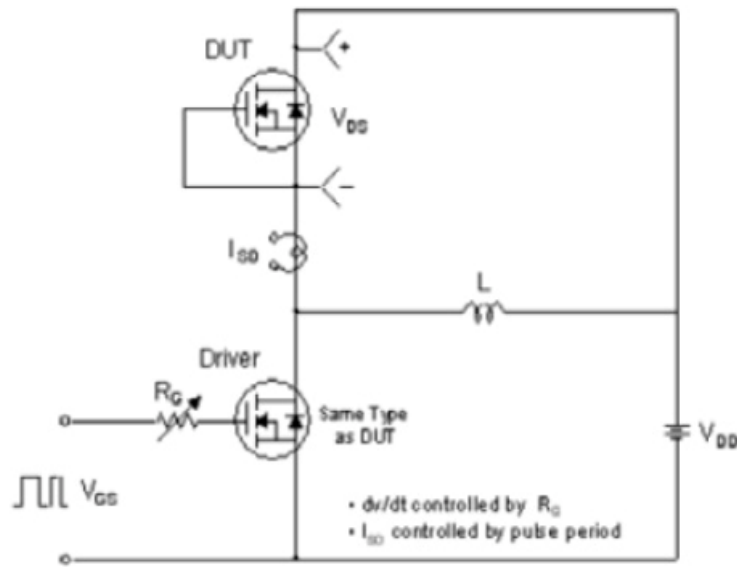

Diode Reverse Recovery Test Circuit and Waveform

SOT-23-3L PACKAGE INFORMATION

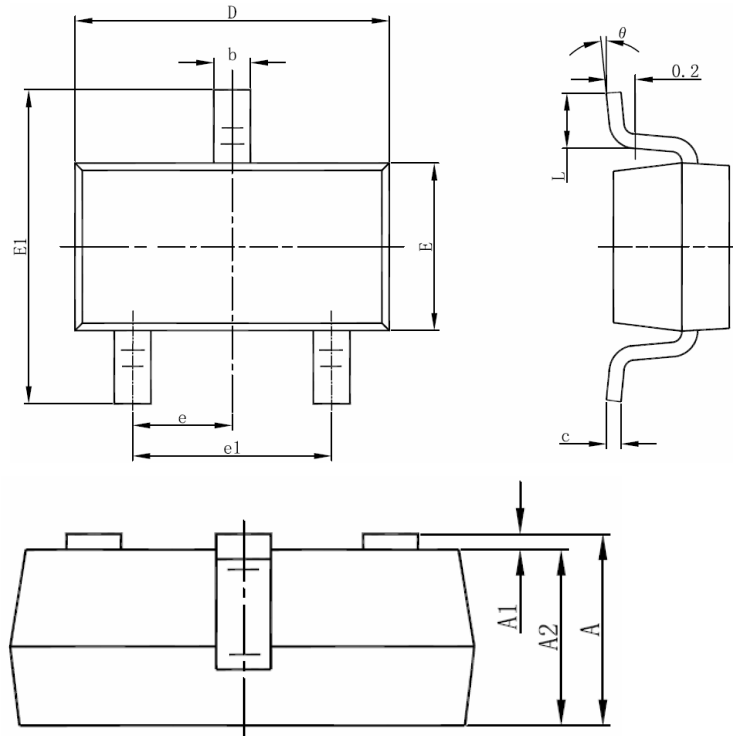

Symbol	Dimensions In Millimeters		Dimensions In Inches	
	Min	Max	Min	Max
A	1.050	1.250	0.041	0.049
A1	0.000	0.100	0.000	0.004
A2	1.050	1.150	0.041	0.045
b	0.300	0.500	0.012	0.020
c	0.100	0.200	0.004	0.008
D	2.820	3.020	0.111	0.119
E	1.500	1.700	0.059	0.067
E1	2.650	2.950	0.104	0.116
e	0.950(BSC)		0.037(BSC)	
e1	1.800	2.000	0.071	0.079
L	0.300	0.600	0.012	0.024
θ	0°	8°	0°	8°

NOTES

1. All dimensions are in millimeters.
2. Tolerance $\pm 0.10\text{mm}$ (4 mil) unless otherwise specified
3. Package body sizes exclude mold flash and gate burrs. Mold flash at the non-lead sides should be less than 5 mils.
4. Dimension L is measured in gauge plane.
5. Controlling dimension is millimeter, converted inch dimensions are not necessarily exact.

The name and content of poisonous and harmful material in products

Part's Name	Hazardous Substance					
	Pb	Hg	Cd	Cr(VI)	PBB	PBDE
Limit	≤0.1%	≤0.1%	≤0.01%	≤0.1%	≤0.1%	≤0.1%
Lead Frame	○	○	○	○	○	○
Molding Compound	○	○	○	○	○	○
Chip	○	○	○	○	○	○
Wire Bonding	○	○	○	○	○	○
Solder	×	○	○	○	○	○
Note	○: means the hazardous material is under the criterion of SJ/T11363-2006. ×: means the hazardous material exceeds the criterion of SJ/T11363-2006.					

Warnings

1. Exceeding the maximum ratings of the device in performance may cause damage to the device, even the permanent failure, which may affect the dependability of the machine. It is suggested to be used under 80 percent of the maximum ratings of the device.
2. When installing the heatsink, please pay attention to the torsional moment and the smoothness of the heatsink.
3. VDMOSFETs is the device which is sensitive to the static electricity, it is necessary to protect the device from being damaged by the static electricity when using it.
4. This publication is made by H&M Semiconductor and subject to regular change without notice.