

## N-Channel Enhancement Mode Power MOSFET

### Description

The HM10N15D uses advanced trench technology and design to provide excellent  $R_{DS(ON)}$  with low gate charge. It can be used in a wide variety of applications.

### General Features

- $V_{DS} = 150V, I_D = 10A$   
 $R_{DS(ON)} < 75m\Omega @ V_{GS}=10V$  (Typ:62m $\Omega$ )  
 $R_{DS(ON)} < 80m\Omega @ V_{GS}=4.5V$  (Typ:68m $\Omega$ )
- High density cell design for ultra low  $R_{dson}$
- Fully characterized avalanche voltage and current
- Good stability and uniformity with high  $E_{AS}$
- Excellent package for good heat dissipation

### Application

- Boost converters
- LED backlighting
- Uninterruptible power supply

**100% UIS TESTED!**

**100%  $\Delta V_d$ s TESTED!**

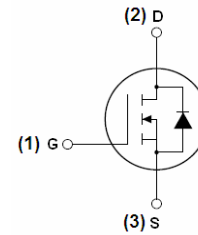

Schematic diagram

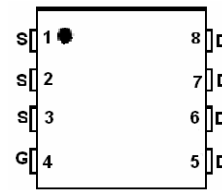

Marking and pin assignment

### Package Marking and Ordering Information

Device Marking	Device	Device Package	Reel Size	Tape width	Quantity
HM10N15D	HM10N15D	DFN5X6-8L	-	-	-

### Absolute Maximum Ratings ( $T_C=25^\circ C$ unless otherwise noted)

Symbol	Parameter	Limit	Unit
$V_{DS}$	Drain-Source Voltage	150	V
$V_{GS}$	Gate-Source Voltage	$\pm 20$	V
$I_D$	Drain Current-Continuous	10	A
$I_D(100^\circ C)$	Drain Current-Continuous( $T_C=100^\circ C$ )	7	A
$I_{DM}$	Pulsed Drain Current	30	A
$P_D$	Maximum Power Dissipation	90	W
	Derating factor	0.6	W/ $^\circ C$
$E_{AS}$	Single pulse avalanche energy <sup>(Note 5)</sup>	80	mJ
$T_J, T_{STG}$	Operating Junction and Storage Temperature Range	-55 To 175	$^\circ C$

### Thermal Characteristic

$R_{\theta JC}$	Thermal Resistance, Junction-to-Case <sup>(Note 2)</sup>	1.7	°C/W
-----------------	--	-----	------

### Electrical Characteristics ( $T_C=25^\circ\text{C}$ unless otherwise noted)

Symbol	Parameter	Condition	Min	Typ	Max	Unit
<b>Off Characteristics</b>						
$BV_{DSS}$	Drain-Source Breakdown Voltage	$V_{GS}=0V, I_D=250\mu A$	150	165	-	V
$I_{DSS}$	Zero Gate Voltage Drain Current	$V_{DS}=150V, V_{GS}=0V$	-	-	1	$\mu A$
$I_{GSS}$	Gate-Body Leakage Current	$V_{GS}=\pm 20V, V_{DS}=0V$	-	-	$\pm 100$	nA
<b>On Characteristics</b> <sup>(Note 3)</sup>						
$V_{GS(th)}$	Gate Threshold Voltage	$V_{DS}=V_{GS}, I_D=250\mu A$	1.2	1.6	2.5	V
$R_{DS(on)}$	Drain-Source On-State Resistance	$V_{GS}=10V, I_D=10A$	-	62	75	m $\Omega$
		$V_{GS}=4.5V, I_D=10A$	-	68	80	m $\Omega$
$g_{FS}$	Forward Transconductance	$V_{DS}=5V, I_D=10A$	-	20	-	S
<b>Dynamic Characteristics</b> <sup>(Note 4)</sup>						
$C_{iss}$	Input Capacitance	$V_{DS}=75V, V_{GS}=0V,$ $F=1.0MHz$	-	2500	-	PF
$C_{oss}$	Output Capacitance		-	68	-	PF
$C_{rss}$	Reverse Transfer Capacitance		-	54	-	PF
<b>Switching Characteristics</b> <sup>(Note 4)</sup>						
$t_{d(on)}$	Turn-on Delay Time	$V_{DD}=75V, R_L=5\Omega$ $V_{GS}=10V, R_{GEN}=3\Omega$	-	18.5	-	nS
$t_r$	Turn-on Rise Time		-	10	-	nS
$t_{d(off)}$	Turn-Off Delay Time		-	22	-	nS
$t_f$	Turn-Off Fall Time		-	8	-	nS
$Q_g$	Total Gate Charge	$V_{DS}=75V, I_D=10A,$ $V_{GS}=10V$	-	60	-	nC
$Q_{gs}$	Gate-Source Charge		-	7.1	-	nC
$Q_{gd}$	Gate-Drain Charge		-	17	-	nC
<b>Drain-Source Diode Characteristics</b>						
$V_{SD}$	Diode Forward Voltage <sup>(Note 3)</sup>	$V_{GS}=0V, I_S=10A$	-	-	1.2	V
$I_S$	Diode Forward Current <sup>(Note 2)</sup>	-	-	-	10	A
$t_{rr}$	Reverse Recovery Time	$T_J = 25^\circ\text{C}, I_F = 10A$ $di/dt = 100A/\mu s$ <sup>(Note 3)</sup>	-	34	-	nS
$Q_{rr}$	Reverse Recovery Charge		-	55	-	nC
$t_{on}$	Forward Turn-On Time	Intrinsic turn-on time is negligible (turn-on is dominated by LS+LD)				

### Notes:

1. Repetitive Rating: Pulse width limited by maximum junction temperature.
2. Surface Mounted on FR4 Board,  $t \leq 10$  sec.
3. Pulse Test: Pulse Width  $\leq 300\mu s$ , Duty Cycle  $\leq 2\%$ .
4. Guaranteed by design, not subject to production
5. EAS condition:  $T_J=25^\circ\text{C}, V_{DD}=50V, V_G=10V, L=0.5mH, R_g=25\Omega$

Test Circuit

1)  $E_{AS}$  Test Circuit

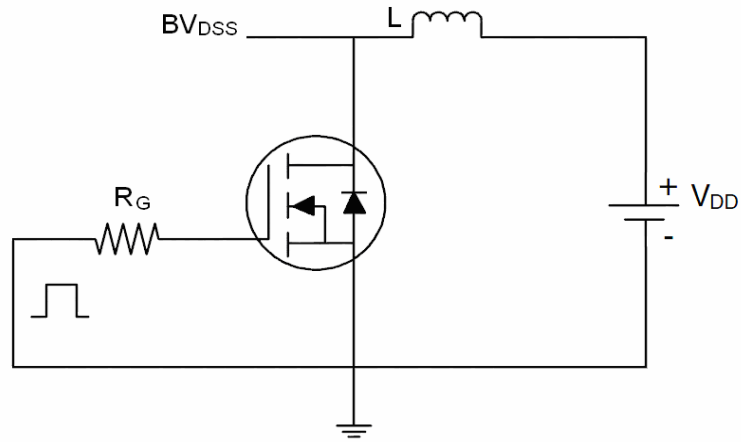

2) Gate Charge Test Circuit

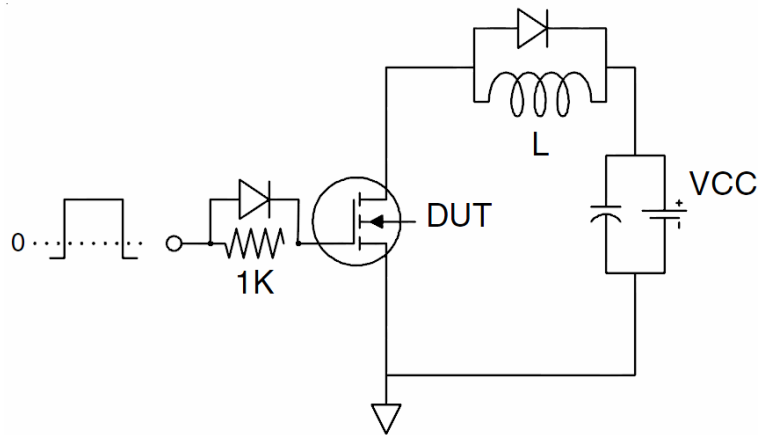

3) Switch Time Test Circuit

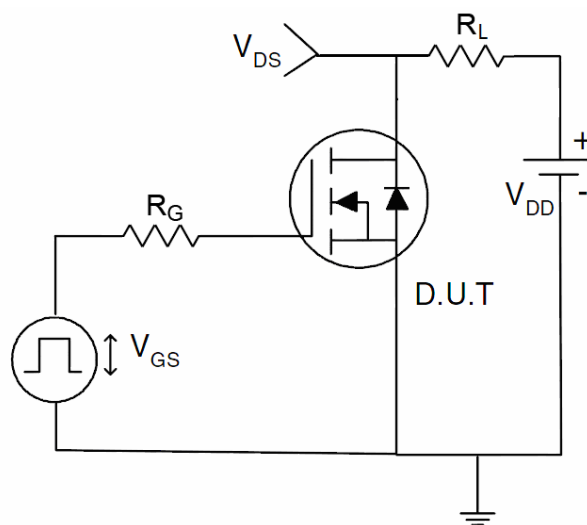

Typical Electrical and Thermal Characteristics (Curves)

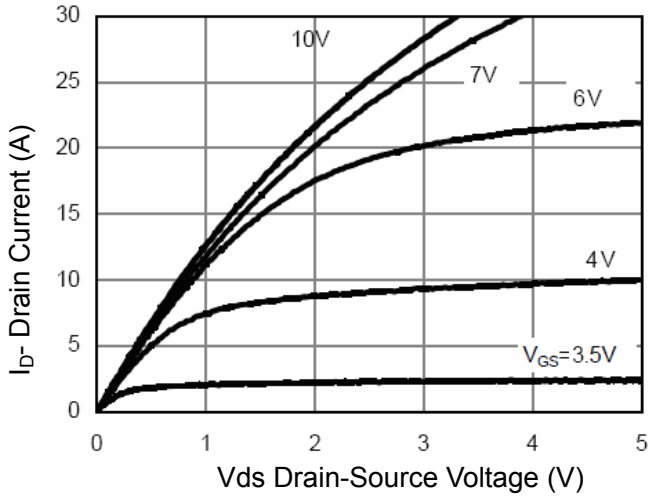

Figure 1 Output Characteristics

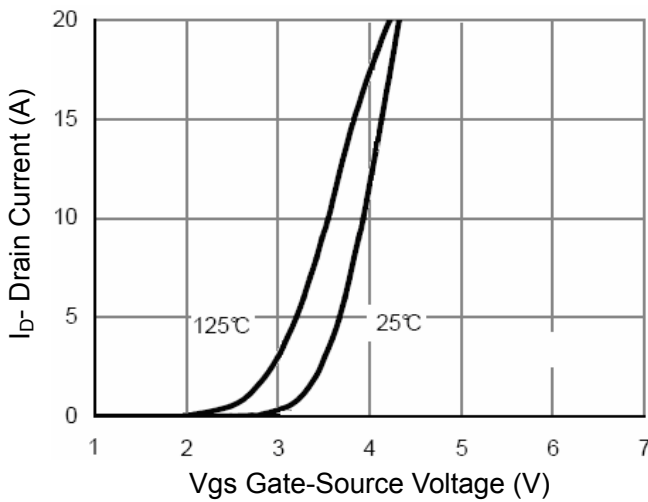

Figure 2 Transfer Characteristics

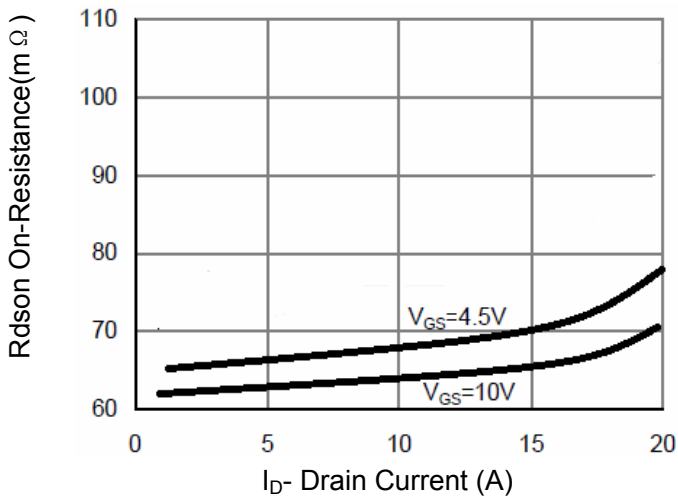

Figure 3 Rdson- Drain Current

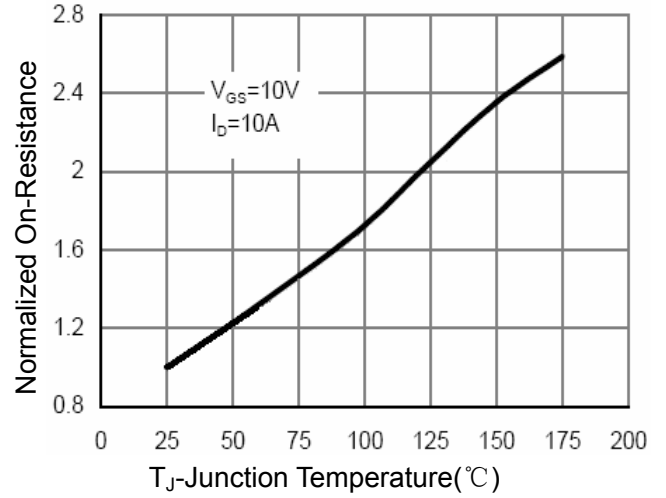

Figure 4 Rdson-Junction Temperature

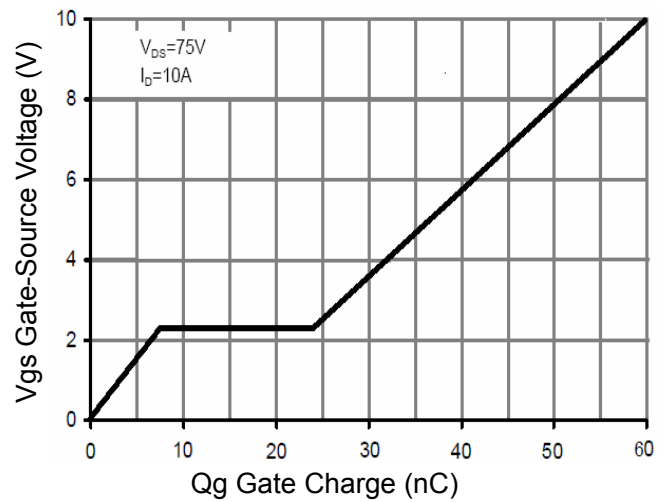

Figure 5 Gate Charge

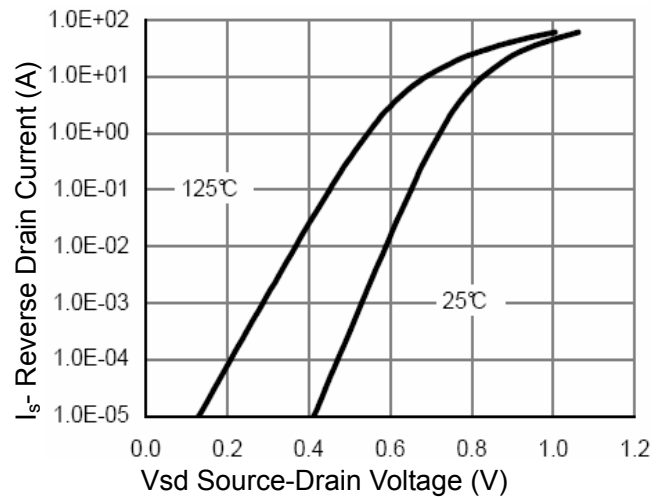

Figure 6 Source- Drain Diode Forward

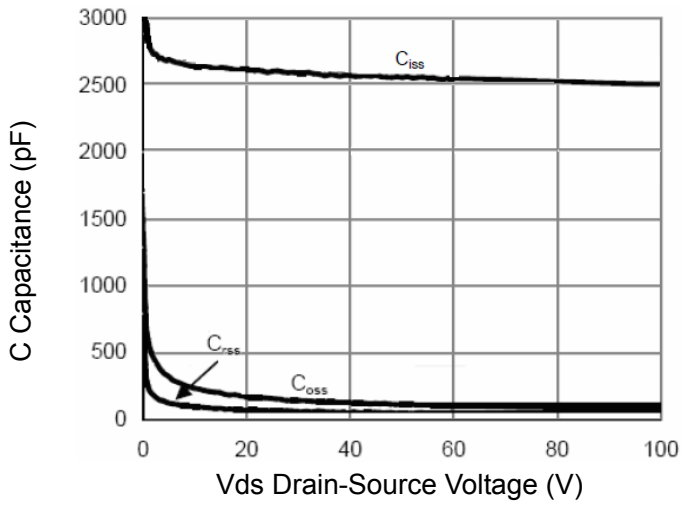

Figure 7 Capacitance vs Vds

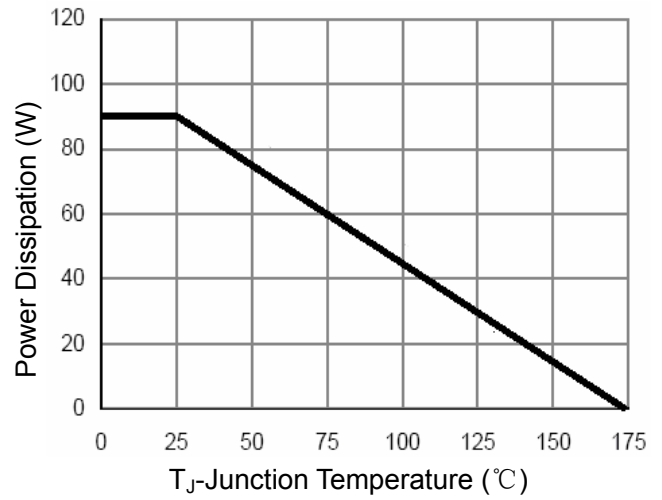

Figure 9 Power De-rating

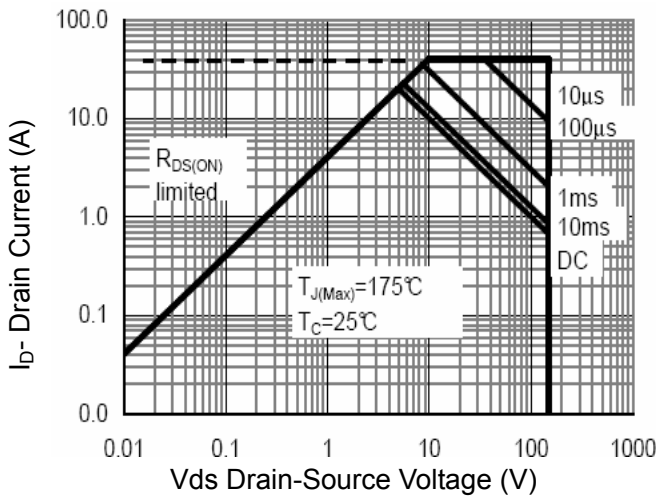

Figure 8 Safe Operation Area

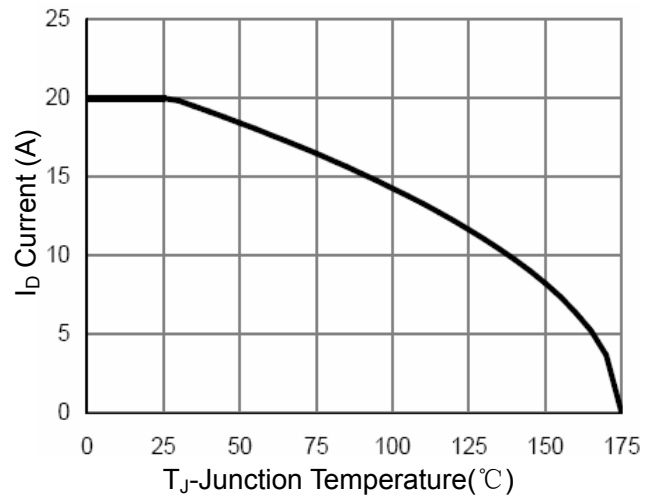

Figure 10 ID Current- Junction Temperature

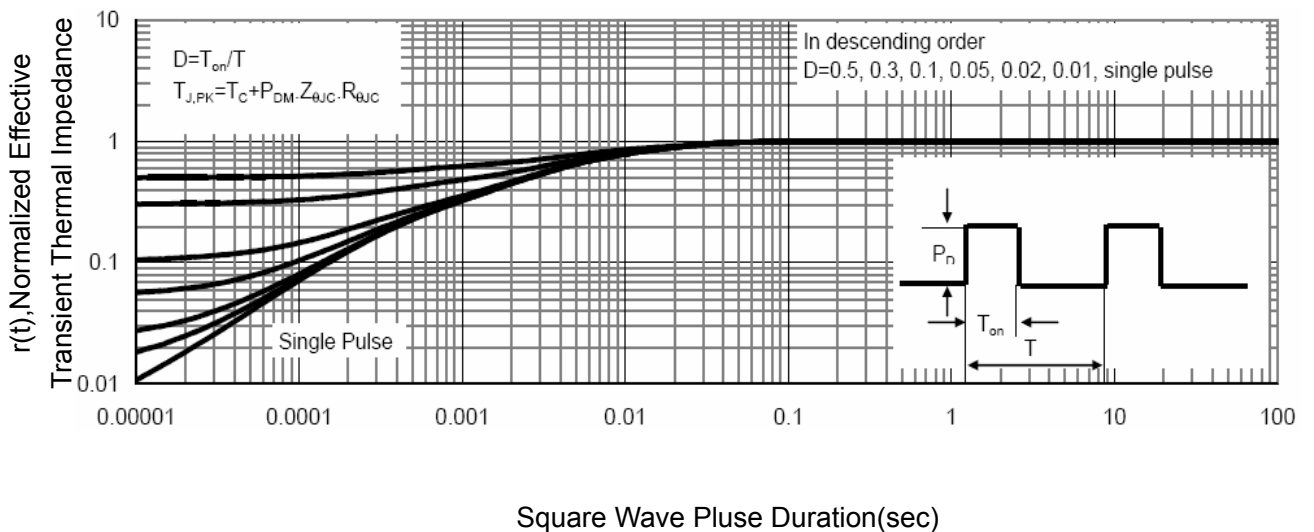
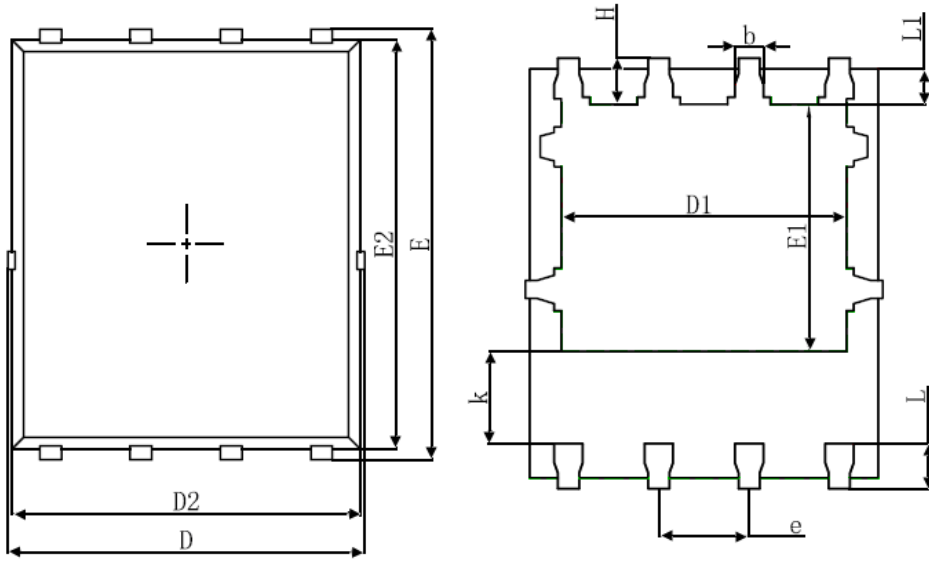

Figure 11 Normalized Maximum Transient Thermal Impedance

DFN5X6-8L Package Information



Top View  
[顶视图]

Bottom View  
[背视图]

Side View  
[侧视图]

Symbol	Dimensions In Millimeters		Dimensions In Inches	
	Min.	Max.	Min.	Max.
A	0.900	1.000	0.035	0.039
A3	0.254REF.		0.010REF.	
D	4.944	5.096	0.195	0.201
E	5.974	6.126	0.235	0.241
D1	3.910	4.110	0.154	0.162
E1	3.375	3.575	0.133	0.141
D2	4.824	4.976	0.190	0.196
E2	5.674	5.826	0.223	0.229
k	1.190	1.390	0.047	0.055
b	0.350	0.450	0.014	0.018
e	1.270TYP.		0.050TYP.	
L	0.559	0.711	0.022	0.028
L1	0.424	0.576	0.017	0.023
H	0.574	0.726	0.023	0.029
$\theta$	8°	12°	8°	12°