

Dual P-Channel Enhancement Mode Power MOSFET

Description

The HM4813 uses advanced trench technology to provide excellent $R_{DS(ON)}$, low gate charge and operation with gate voltages as low as 4.5V. This device is suitable for use as a load switch or in PWM applications.

General Features

- $V_{DS} = -30V, I_D = -7A$
 $R_{DS(ON)} < 70m\Omega @ V_{GS} = -4.5V$
 $R_{DS(ON)} < 42m\Omega @ V_{GS} = -10V$
- High Power and current handing capability
- Lead free product is acquired
- Surface mount package

Application

- PWM applications
- Load switch
- Power management

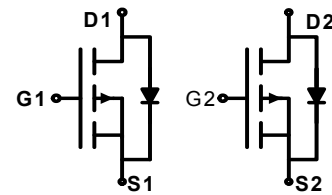

Schematic diagram

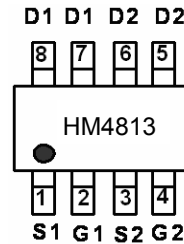

Marking and pin Assignment

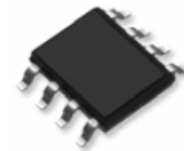

SOP-8 top view

Package Marking and Ordering Information

Device Marking	Device	Device Package	Reel Size	Tape width	Quantity
HM4813	HM4813	SOP-8	Ø330mm	12mm	2500 units

Absolute Maximum Ratings ($T_A = 25^\circ\text{C}$ unless otherwise noted)

Parameter	Symbol	Limit	Unit
Drain-Source Voltage	V_{DS}	-30	V
Gate-Source Voltage	V_{GS}	± 20	V
Drain Current-Continuous	I_D	-7	A
Drain Current-Pulsed ^(Note 1)	I_{DM}	-28	A
Maximum Power Dissipation	P_D	3	W
Operating Junction and Storage Temperature Range	T_J, T_{STG}	-55 To 150	$^\circ\text{C}$

Thermal Characteristic

Thermal Resistance, Junction-to-Ambient ^(Note 2)	$R_{\theta JA}$	41.67	$^\circ\text{C/W}$
---	-----------------	-------	--------------------

Electrical Characteristics ($T_A = 25^\circ\text{C}$ unless otherwise noted)

Parameter	Symbol	Condition	Min	Typ	Max	Unit
Off Characteristics						

Parameter	Symbol	Condition	Min	Typ	Max	Unit
Drain-Source Breakdown Voltage	BV_{DSS}	$V_{GS}=0V, I_D=-250\mu A$	-30	-33	-	V
Zero Gate Voltage Drain Current	I_{DSS}	$V_{DS}=-30V, V_{GS}=0V$	-	-	-1	μA
Gate-Body Leakage Current	I_{GSS}	$V_{GS}=\pm 20V, V_{DS}=0V$	-	-	± 100	nA
On Characteristics ^(Note 3)						
Gate Threshold Voltage	$V_{GS(th)}$	$V_{DS}=V_{GS}, I_D=-250\mu A$	-1.4	-1.9	-2.4	V
Drain-Source On-State Resistance	$R_{DS(ON)}$	$V_{GS}=-10V, I_D=-7A$	-	30	42	m Ω
		$V_{GS}=-4.5V, I_D=-5A$	-	53	72	m Ω
Forward Transconductance	g_{FS}	$V_{DS}=-10V, I_D=-7A$	20	-	-	S
Dynamic Characteristics ^(Note 4)						
Input Capacitance	C_{ISS}	$V_{DS}=-15V, V_{GS}=0V,$ $F=1.0MHz$	-	1750	-	PF
Output Capacitance	C_{OSS}		-	215	-	PF
Reverse Transfer Capacitance	C_{RSS}		-	180	-	PF
Switching Characteristics ^(Note 4)						
Turn-on Delay Time	$t_{d(on)}$	$V_{DD}=-15V, I_D=-7A,$ $V_{GS}=-10V, R_{GEN}=1\Omega$	-	9	-	nS
Turn-on Rise Time	t_r		-	8	-	nS
Turn-Off Delay Time	$t_{d(off)}$		-	28	-	nS
Turn-Off Fall Time	t_f		-	10	-	nS
Total Gate Charge	Q_g	$V_{DS}=-15V, I_D=-7A, V_{GS}=-10V$	-	24	-	nC
Gate-Source Charge	Q_{gs}		-	3.5	-	nC
Gate-Drain Charge	Q_{gd}		-	6	-	nC
Drain-Source Diode Characteristics						
Diode Forward Voltage ^(Note 3)	V_{SD}	$V_{GS}=0V, I_S=-2A$	-	-	-1.2	V

Notes:

1. Repetitive Rating: Pulse width limited by maximum junction temperature.
2. Surface Mounted on FR4 Board, $t \leq 10$ sec.
3. Pulse Test: Pulse Width $\leq 300\mu s$, Duty Cycle $\leq 2\%$.
4. Guaranteed by design, not subject to production

Typical Electrical and Thermal Characteristics

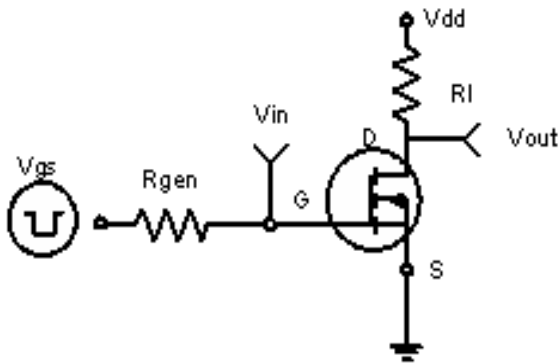

Figure 1: Switching Test Circuit

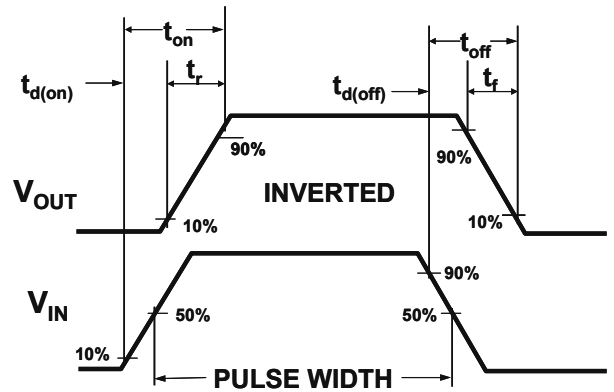

Figure 2: Switching Waveforms

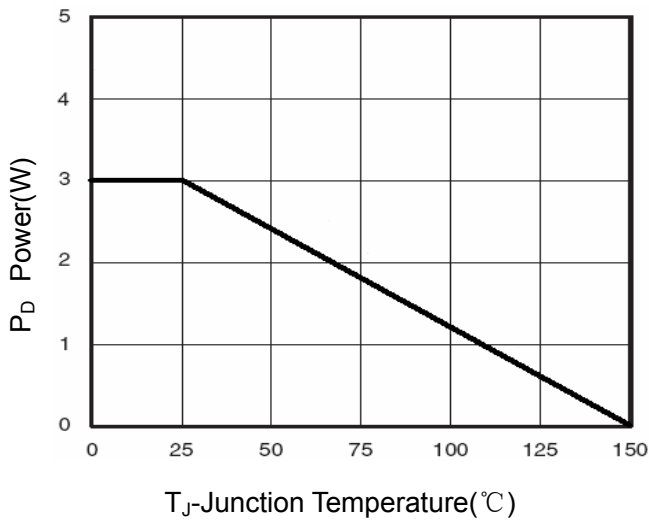

Figure 3 Power Dissipation

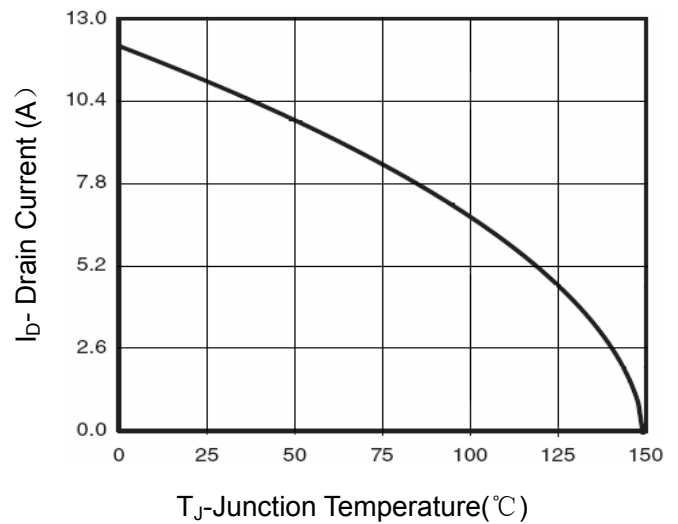

Figure 4 Drain Current

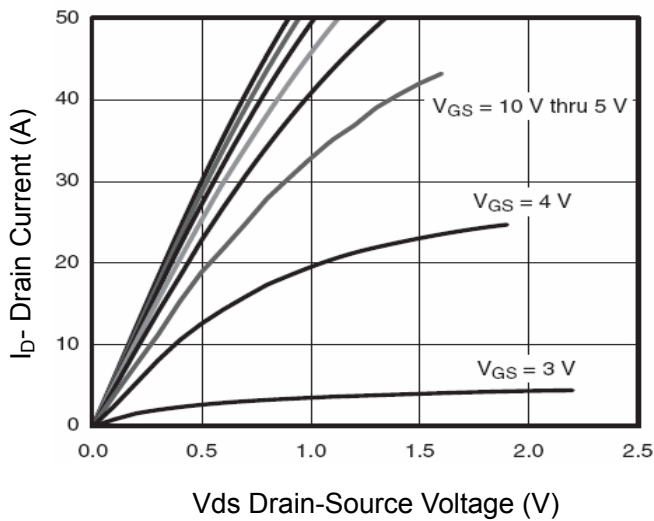

Figure 5 Output Characteristics

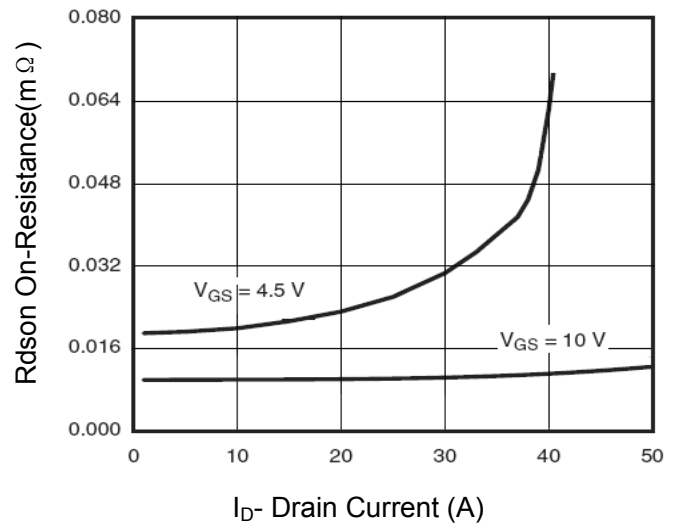

Figure 6 Drain-Source On-Resistance

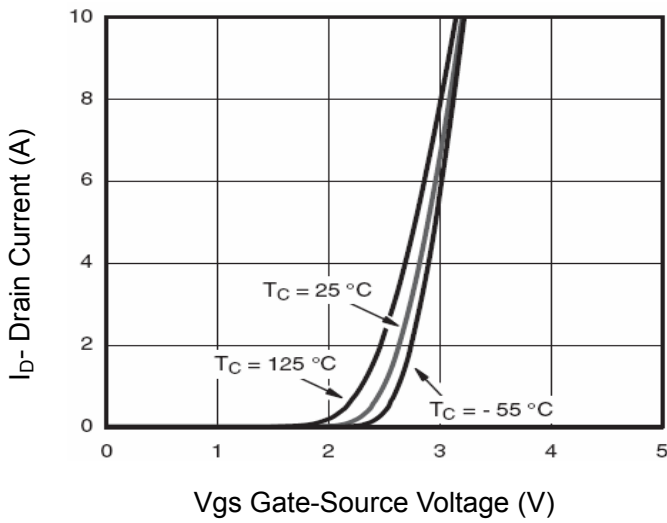

Figure 7 Transfer Characteristics

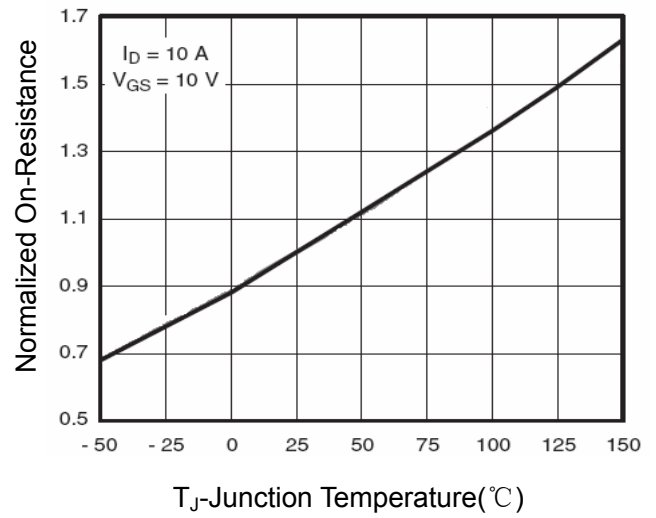

Figure 8 Drain-Source On-Resistance

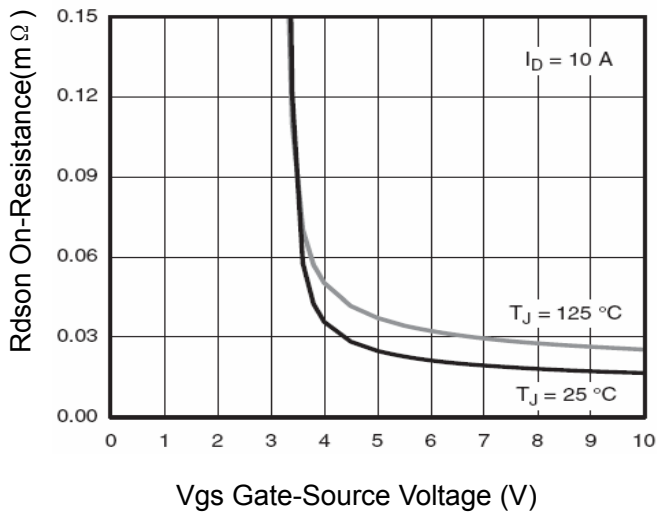

Figure 9 $R_{DS(on)}$ vs V_{GS}

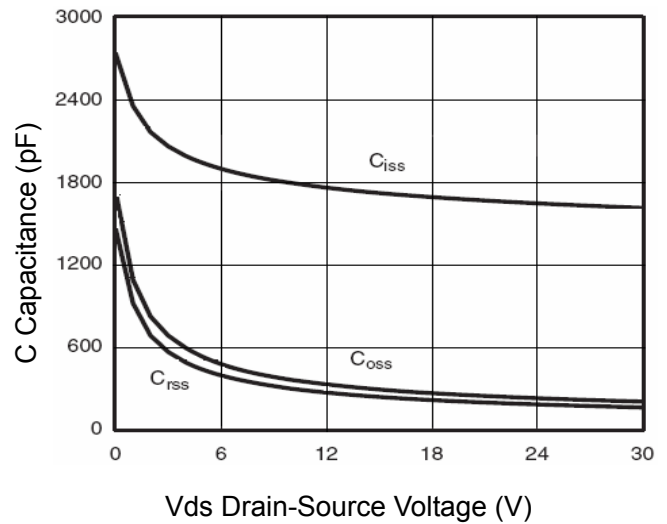

Figure 10 Capacitance vs V_{DS}

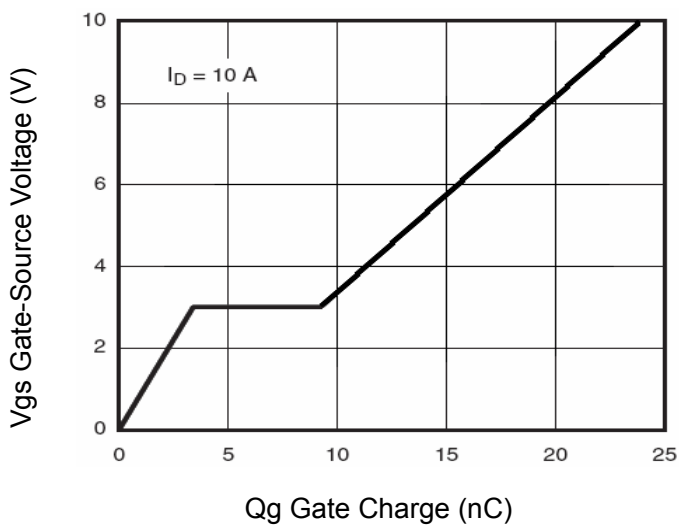

Figure 11 Gate Charge

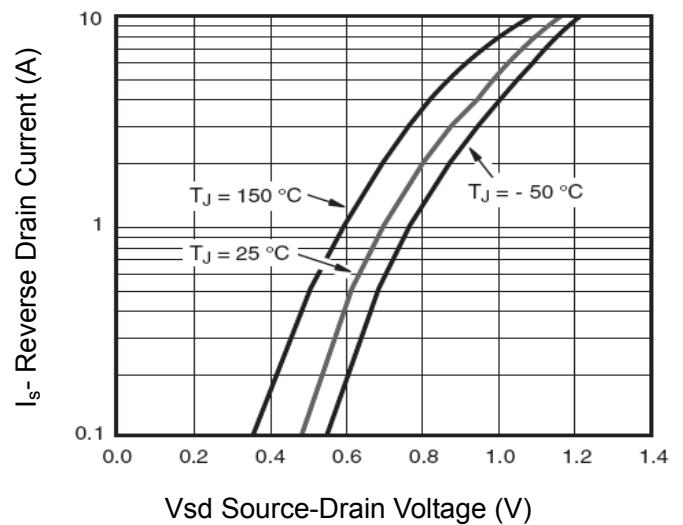

Figure 12 Source- Drain Diode Forward

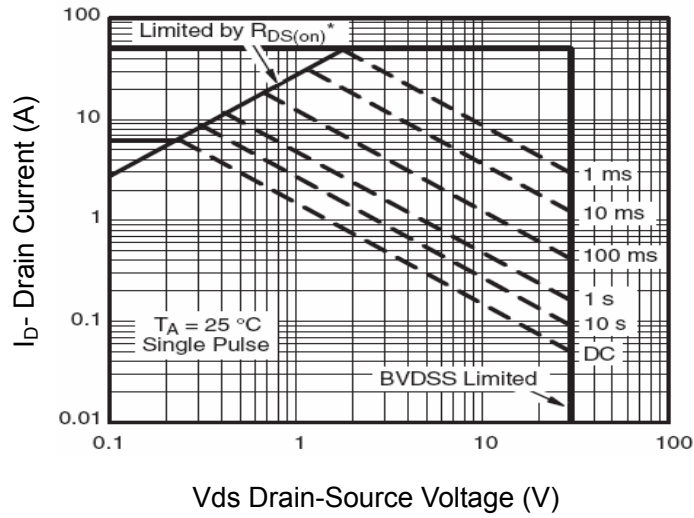

Figure 13 Safe Operation Area

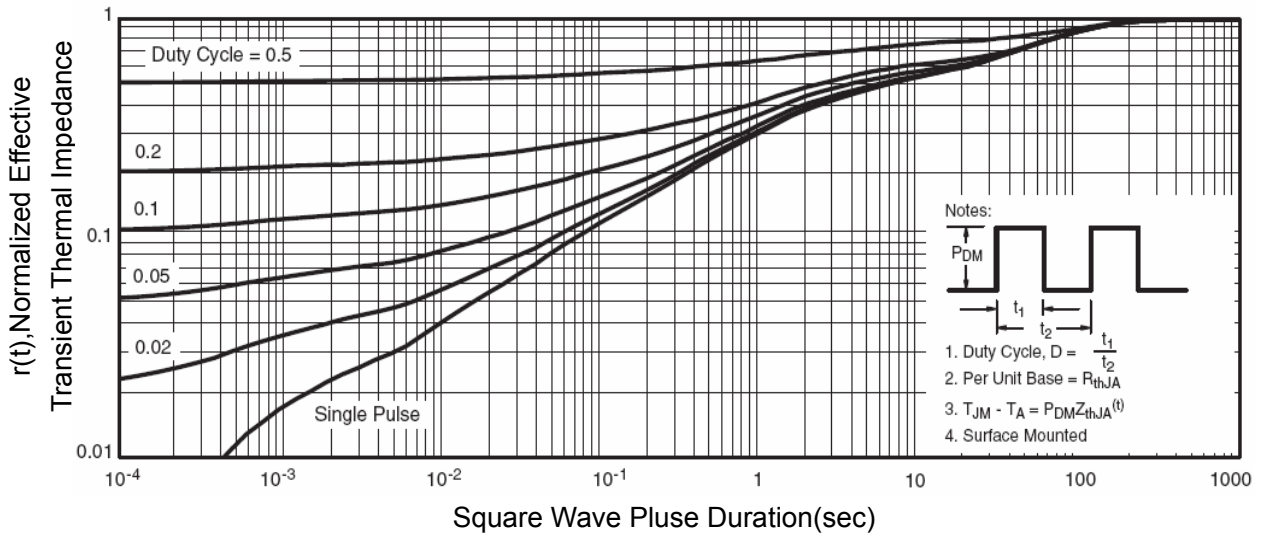
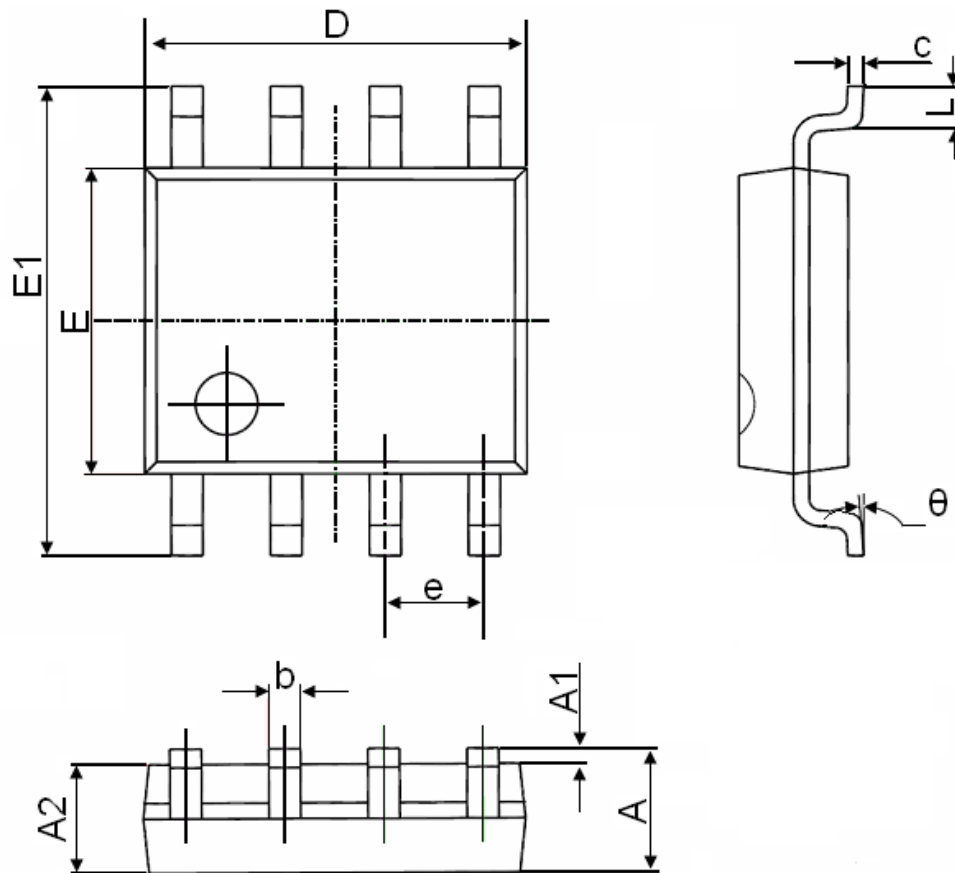

Figure 14 Normalized Maximum Transient Thermal Impedance

SOP-8 Package Information



Symbol	Dimensions In Millimeters		Dimensions In Inches	
	Min.	Max.	Min.	Max.
A	1.350	1.750	0.053	0.069
A1	0.100	0.250	0.004	0.010
A2	1.350	1.550	0.053	0.061
b	0.330	0.510	0.013	0.020
c	0.170	0.250	0.006	0.010
D	4.700	5.100	0.185	0.200
E	3.800	4.000	0.150	0.157
E1	5.800	6.200	0.228	0.244
e	1.270(BSC)		0.050(BSC)	
L	0.400	1.270	0.016	0.050
theta	0°	8°	0°	8°