

N-Channel Super Junction Power MOSFET III

General Description

The series of devices use advanced trench gate super junction technology and design to provide excellent $R_{DS(ON)}$ with low gate charge. This super junction MOSFET fits the industry's AC-DC SMPS requirements for PFC, AC/DC power conversion, and industrial power applications.

Features

- New technology for high voltage device
- Low on-resistance and low conduction losses
- Small package
- Ultra Low Gate Charge cause lower driving requirements
- 100% Avalanche Tested
- ROHS compliant

Application

- Power factor correction (PFC)
- Switched mode power supplies(SMPS)
- Uninterruptible Power Supply (UPS)

V_{DS}	900	V
$R_{DS(ON)TYP}$	1.5	Ω
I_D	5	A

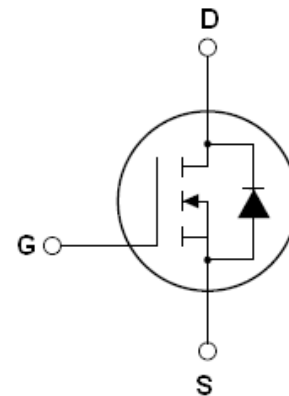

Schematic diagram

Package Marking And Ordering Information

Device	Device Package	Marking
HMS5N90R	SOT223-3L	HMS5N90R

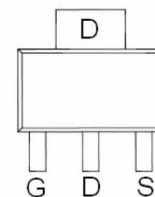

SOT223-3L

Table 1. Absolute Maximum Ratings ($T_c=25^\circ\text{C}$)

Parameter	Symbol	Value	Unit
Drain-Source Voltage ($V_{GS}=0V$)	V_{DS}	900	V
Gate-Source Voltage ($V_{DS}=0V$), AC ($f>1\text{ Hz}$)	V_{GS}	± 30	V
Continuous Drain Current at $T_c=25^\circ\text{C}$	$I_{D(DC)}$	5	A
Continuous Drain Current at $T_c=100^\circ\text{C}$	$I_{D(DC)}$	3	A
Pulsed drain current (Note 1)	$I_{DM(pluse)}$	20	A
Maximum Power Dissipation($T_c=25^\circ\text{C}$)	P_D	46	W
Derate above 25°C		0.37	W/ $^\circ\text{C}$
Single pulse avalanche energy (Note2)	E_{AS}	52	mJ
Avalanche current (Note 1)	I_{AR}	0.9	A
Repetitive Avalanche energy, t_{AR} limited by T_{jmax} (Note 1)	E_{AR}	0.14	mJ
Parameter	Symbol	Value	Unit

Drain Source voltage slope, $V_{DS} \leq 480V$,	dv/dt	50	V/ns
Reverse diode dv/dt, $V_{DS} \leq 480V, I_{SD} < I_D$	dv/dt	15	V/ns
Operating Junction and Storage Temperature Range	T_J, T_{STG}	-55...+150	°C

Table 2. Thermal Characteristic

Parameter	Symbol	Value	Unit
Thermal Resistance, Junction-to-Case (Maximum)	R_{thJC}	2.72	°C/W
Thermal Resistance, Junction-to-Ambient (Maximum)	R_{thJA}	75	°C/W

Table 3. Electrical Characteristics (TA=25°C unless otherwise noted)

Parameter	Symbol	Condition	Min	Typ	Max	Unit
On/off states						
Drain-Source Breakdown Voltage	BV_{DSS}	$V_{GS}=0V, I_D=250\mu A$	900			V
Zero Gate Voltage Drain Current($T_C=25^\circ C$)	I_{DSS}	$V_{DS}=900V, V_{GS}=0V$			1	μA
Zero Gate Voltage Drain Current($T_C=125^\circ C$)	I_{DSS}	$V_{DS}=900V, V_{GS}=0V$			50	μA
Gate-Body Leakage Current	I_{GSS}	$V_{GS}=\pm 20V, V_{DS}=0V$			± 100	nA
Gate Threshold Voltage	$V_{GS(th)}$	$V_{DS}=V_{GS}, I_D=250\mu A$	2.6		4.4	V
Drain-Source On-State Resistance	$R_{DS(on)}$	$V_{GS}=10V, I_D=2.5A$	1.48		1.5	Ω
Dynamic Characteristics						
Input Capacitance	C_{iss}	$V_{DS}=50V, V_{GS}=0V,$ $F=1.0MHz$		370		pF
Output Capacitance	C_{oss}			25		pF
Reverse Transfer Capacitance	C_{rss}			0.5		pF
Total Gate Charge	Q_g	$V_{DS}=480V, I_D=5A,$ $V_{GS}=10V$		10.5	15	nC
Gate-Source Charge	Q_{gs}			2.6		nC
Gate-Drain Charge	Q_{gd}			5.3		nC
Switching times						
Turn-on Delay Time	$t_{d(on)}$	$V_{DD}=420V, I_D=3A,$ $R_G=5\Omega, V_{GS}=10V$		8		nS
Turn-on Rise Time	t_r			4		nS
Turn-Off Delay Time	$t_{d(off)}$			55		nS
Turn-Off Fall Time	t_f			11		nS
Source- Drain Diode Characteristics						
Source-drain current(Body Diode)	I_{SD}	$T_C=25^\circ C$			5	A
Pulsed Source-drain current(Body Diode)	I_{SDM}				20	A
Forward on voltage	V_{SD}	$T_J=25^\circ C, I_{SD}=5A, V_{GS}=0V$		0.9	1.2	V
Reverse Recovery Time	t_{rr}	$T_J=25^\circ C, I_F=2.5A, di/dt=100A/\mu s$		210		nS
Reverse Recovery Charge	Q_{rr}			0.66		μC
Peak reverse recovery current	I_{rrm}			6.5		A

Notes: 1.Repetitive Rating: Pulse width limited by maximum junction temperature

2. $T_J=25^\circ C, V_{DD}=50V, V_G=10V, R_G=25\Omega$

TYPICAL ELECTRICAL AND THERMAL CHARACTERISTICS (curves)

Figure1. Safe operating area

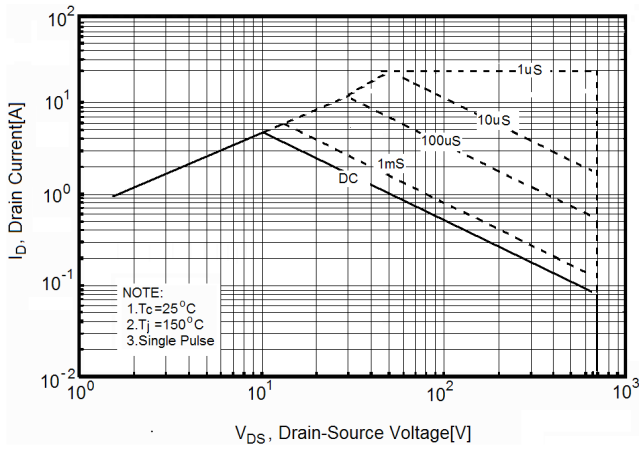

Figure2. Source-Drain Diode Forward Voltage

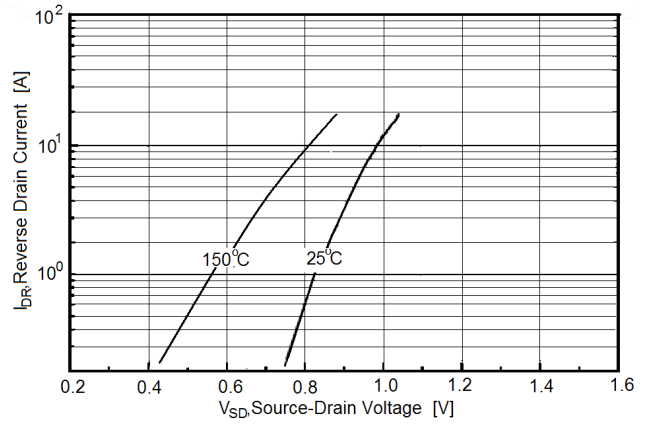

Figure3. Output characteristics

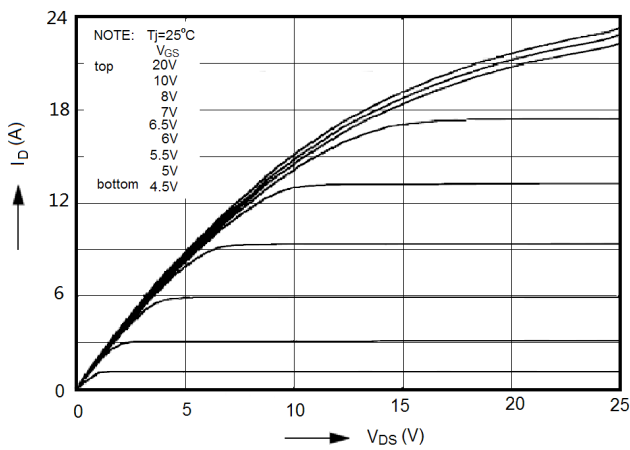

Figure4. Transfer characteristics

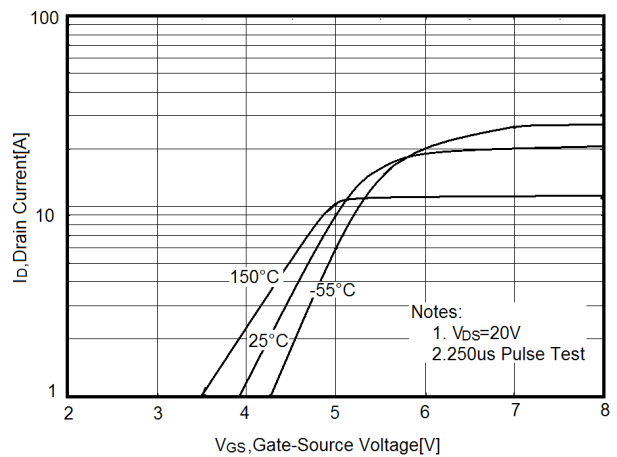

Figure5. Static drain-source on resistance

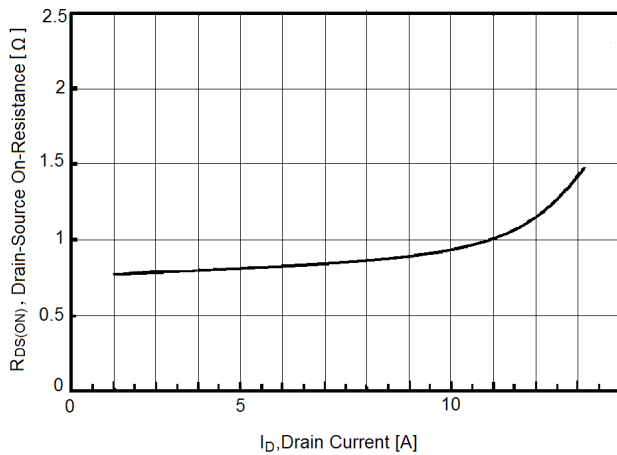

Figure6. $R_{DS(ON)}$ vs Junction Temperature

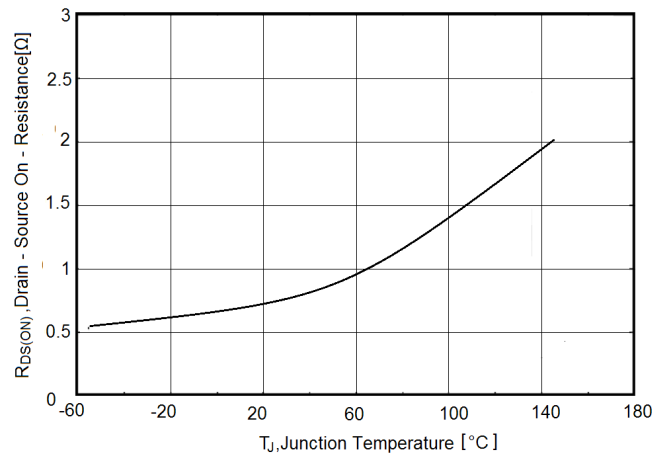

Figure7. BV_{DSS} vs Junction Temperature

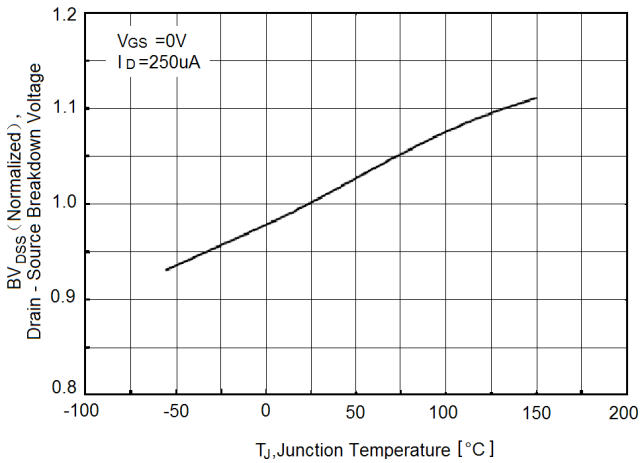

Figure8. Maximum I_D vs Junction Temperature

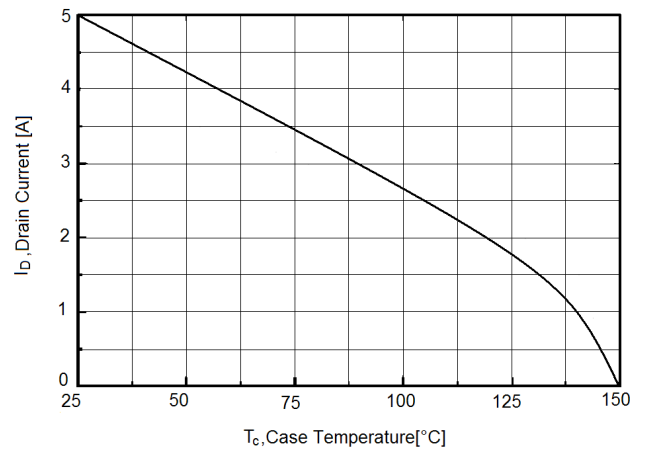

Figure9. Gate charge waveforms

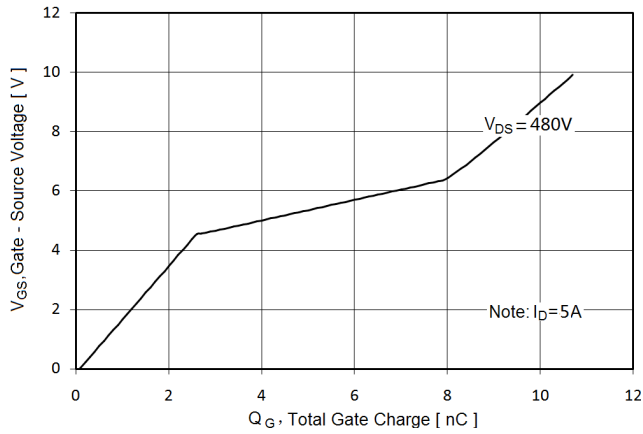

Figure10. Capacitance

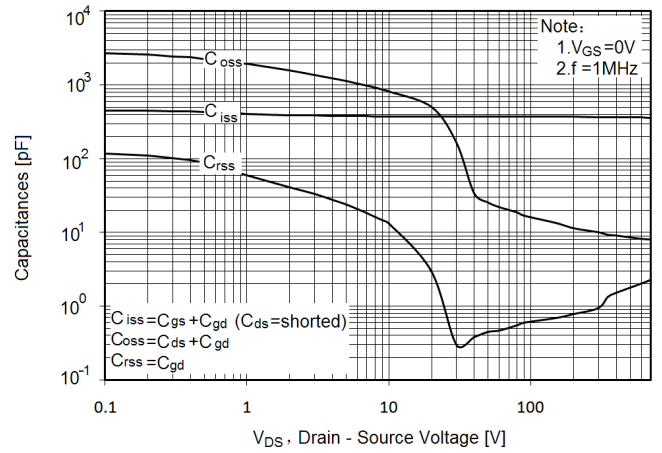
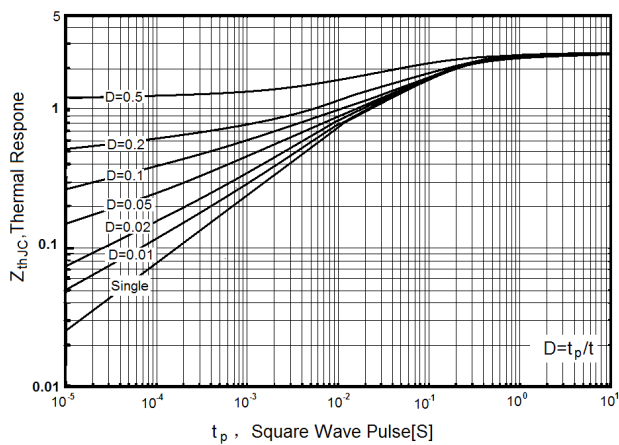
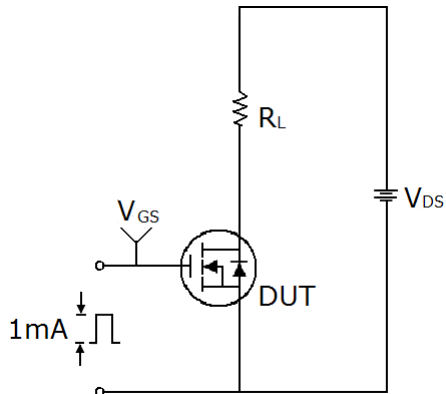

Figure11. Transient Thermal Impedance



Test circuit

1) Gate charge test circuit & Waveform



2) Switch Time Test Circuit:

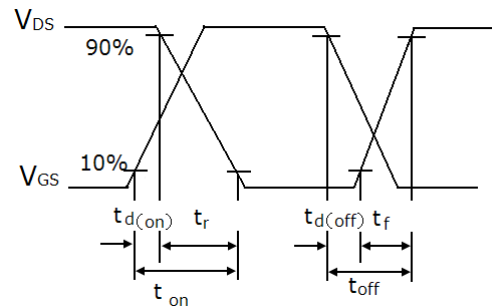
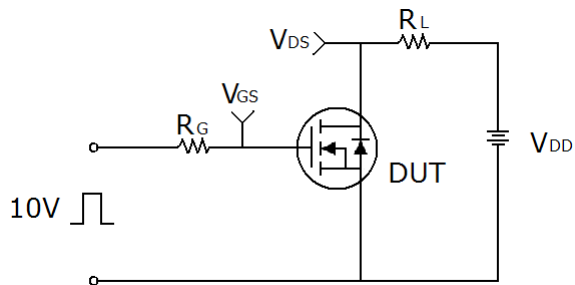

3) Unclamped Inductive Switching Test Circuit & Waveforms

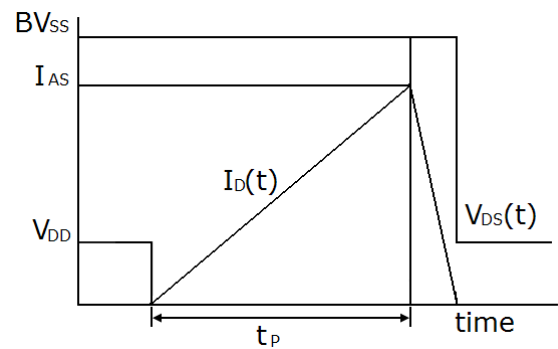

SOT-223-3L Package Information

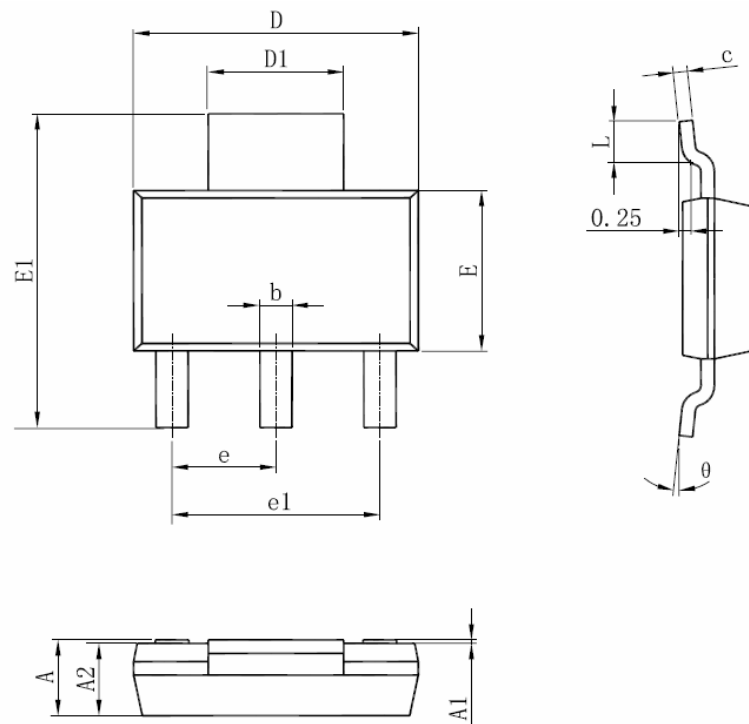

Symbol	Dimensions In Millimeters		Dimensions In Inches	
	Min	Max	Min	Max
A	1.520	1.800	0.060	0.071
A1	0.000	0.100	0.000	0.004
A2	1.500	1.700	0.059	0.067
b	0.660	0.820	0.026	0.032
c	0.250	0.350	0.010	0.014
D	6.200	6.400	0.244	0.252
D1	2.900	3.100	0.114	0.122
E	3.300	3.700	0.130	0.146
E1	6.830	7.070	0.269	0.278
e	2.300(BSC)		0.091(BSC)	
e1	4.500	4.700	0.177	0.185
L	0.900	1.150	0.035	0.045
θ	0°	10°	0°	10°

Notes

1. All dimensions are in millimeters.
2. Tolerance $\pm 0.10\text{mm}$ (4 mil) unless otherwise specified
3. Package body sizes exclude mold flash and gate burrs. Mold flash at the non-lead sides should be less than 5 mils.
4. Dimension L is measured in gauge plane.
5. Controlling dimension is millimeter, converted inch dimensions are not necessarily exact.