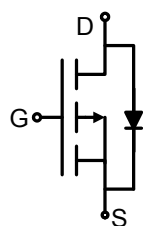
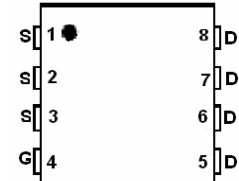

P-Channel Enhancement Mode Power MOSFET

<p>DESCRIPTION</p> <p>The HM20P03Q uses advanced trench technology to provide excellent $R_{DS(ON)}$, low gate charge and operation with gate voltages as low as 4.5V.</p> <p>GENERAL FEATURES</p> <ul style="list-style-type: none"> ● $V_{DS} = -30V, I_D = -20A$ $R_{DS(ON)} < 34m\Omega @ V_{GS} = -4.5V$ $R_{DS(ON)} < 23m\Omega @ V_{GS} = -10V$ ● High Power and current handing capability ● Lead free product is acquired ● Surface Mount Package <p>Application</p> <ul style="list-style-type: none"> ● Battery Switch ● Load switch ● Power management 	 <p style="text-align: center;">Schematic diagram</p>  <p style="text-align: center;">Marking and pin assignment</p>
--	--

Package Marking And Ordering Information

Device Marking	Device	Device Package	Reel Size	Tape width	Quantity
HM20P03Q	HM20P03Q	DFN3X3-8L	Ø330mm	12mm	5000 units

Absolute Maximum Ratings (TA=25°C unless otherwise noted)

Parameter	Symbol	Limit	Unit
Drain-Source Voltage	V_{DS}	-30	V
Gate-Source Voltage	V_{GS}	±20	V
Drain Current-Continuous	I_D	-20	A
Drain Current-Pulsed (Note 1)	I_{DM}	-60	A
Maximum Power Dissipation	P_D	50	W
Operating Junction and Storage Temperature Range	T_J, T_{STG}	-55 To 150	°C

Thermal Characteristic

Thermal Resistance, Junction-to-Ambient (Note 2)	$R_{\theta JA}$	40	°C/W
--	-----------------	----	------

Electrical Characteristics (TA=25°C unless otherwise noted)

Parameter	Symbol	Condition	Min	Typ	Max	Unit
Off Characteristics						
Drain-Source Breakdown Voltage	BV_{DSS}	$V_{GS} = 0V, I_D = -250\mu A$	-30	-33	-	V

Zero Gate Voltage Drain Current	I_{DSS}	$V_{DS}=-30V, V_{GS}=0V$	-	-	-1	μA
Gate-Body Leakage Current	I_{GSS}	$V_{GS}=\pm 20V, V_{DS}=0V$	-	-	± 100	nA
On Characteristics (Note 3)						
Gate Threshold Voltage	$V_{GS(th)}$	$V_{DS}=V_{GS}, I_D=-250\mu A$	-1	-1.5	-2.5	V
Drain-Source On-State Resistance	$R_{DS(on)}$	$V_{GS}=-10V, I_D=-10A$	-	16	23	m Ω
		$V_{GS}=-4.5V, I_D=-7.0A$	-	25	34	m Ω
Forward Transconductance	g_{FS}	$V_{DS}=-15V, I_D=-9.1A$	10	-	-	S
Dynamic Characteristics (Note4)						
Input Capacitance	C_{iss}	$V_{DS}=-15V, V_{GS}=0V,$ $F=1.0MHz$	-	1600	-	PF
Output Capacitance	C_{oss}		-	350	-	PF
Reverse Transfer Capacitance	C_{rss}		-	300	-	PF
Switching Characteristics (Note 4)						
Turn-on Delay Time	$t_{d(on)}$	$V_{DD}=-15V, I_D=-1A,$ $V_{GS}=-10V, R_{GEN}=6\Omega$	-	10	-	nS
Turn-on Rise Time	t_r		-	15	-	nS
Turn-Off Delay Time	$t_{d(off)}$		-	110	-	nS
Turn-Off Fall Time	t_f		-	70	-	nS
Total Gate Charge	Q_g	$V_{DS}=-15V, I_D=-9.1A$ $V_{GS}=-10V$	-	30	-	nC
Gate-Source Charge	Q_{gs}		-	5.5	-	nC
Gate-Drain Charge	Q_{gd}		-	8	-	nC
Drain-Source Diode Characteristics						
Diode Forward Voltage (Note 3)	V_{SD}	$V_{GS}=0V, I_S=-2.1A$	-	-	-1.2	V

Notes:

1. Repetitive Rating: Pulse width limited by maximum junction temperature.
2. Surface Mounted on FR4 Board, $t \leq 10$ sec.
3. Pulse Test: Pulse Width $\leq 300\mu s$, Duty Cycle $\leq 2\%$.
4. Guaranteed by design, not subject to production

TYPICAL ELECTRICAL AND THERMAL CHARACTERISTICS



Figure 1: Switching Test Circuit



Figure 2: Switching Waveforms

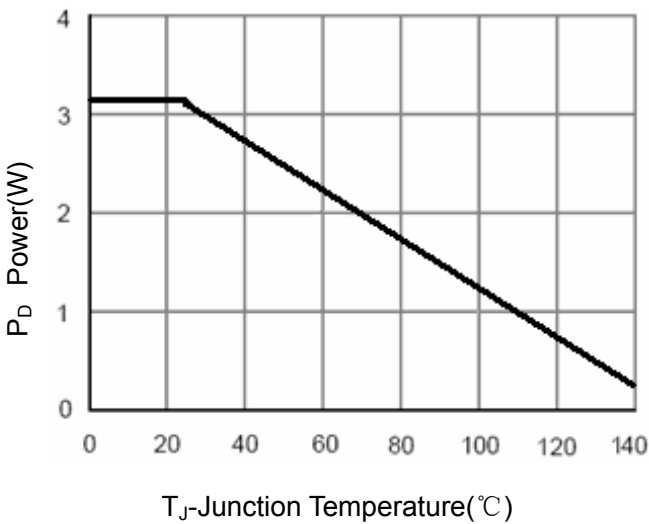

Figure 3 Power Dissipation

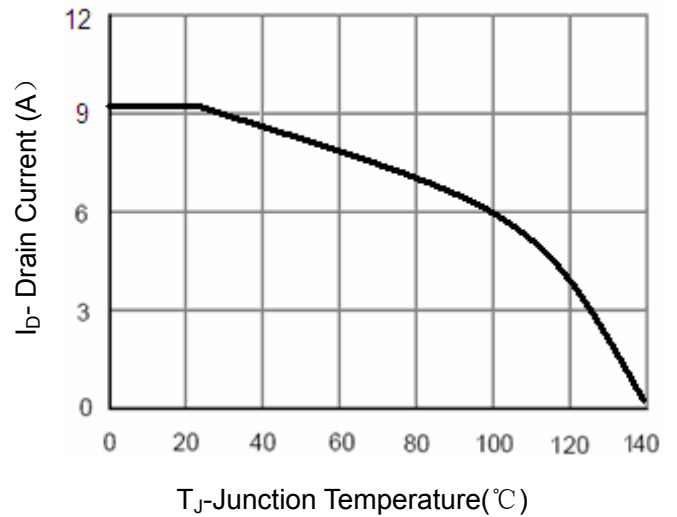

Figure 4 Drain Current

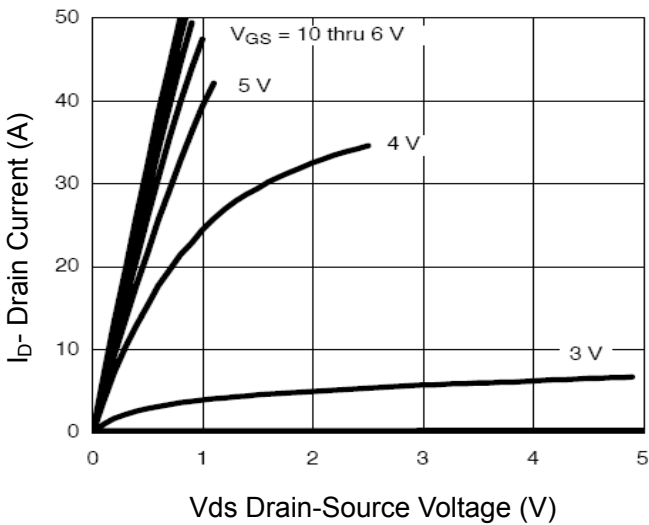

Figure 5 Output CHARACTERISTICS

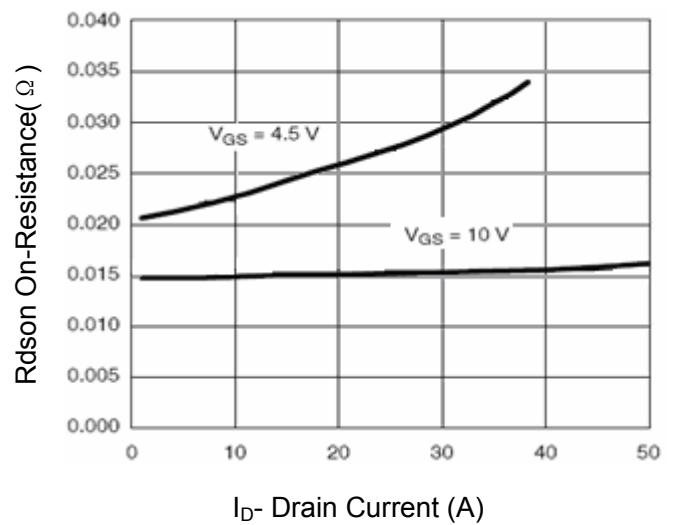

Figure 6 Drain-Source On-Resistance

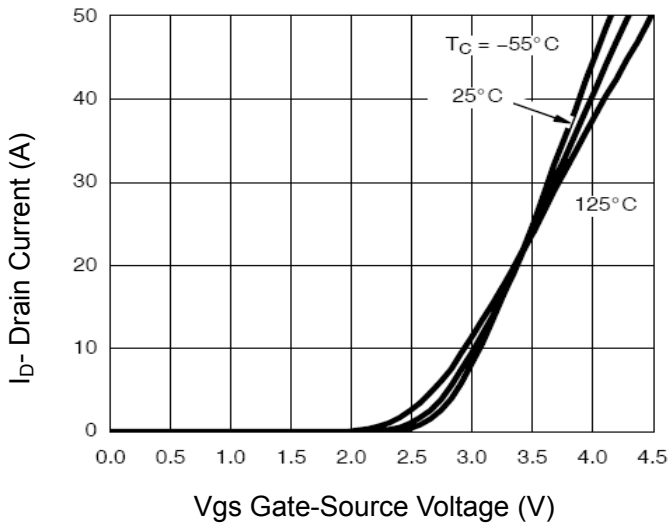

Figure 7 Transfer Characteristics

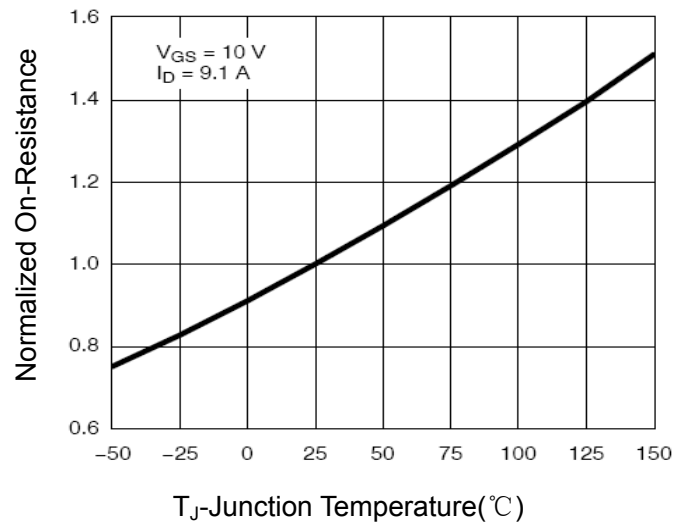

Figure 8 Drain-Source On-Resistance

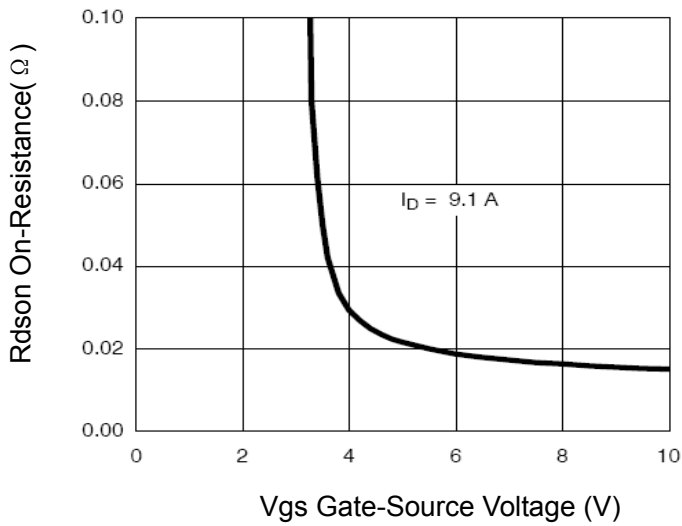

Figure 9 $R_{DS(on)}$ vs V_{GS}

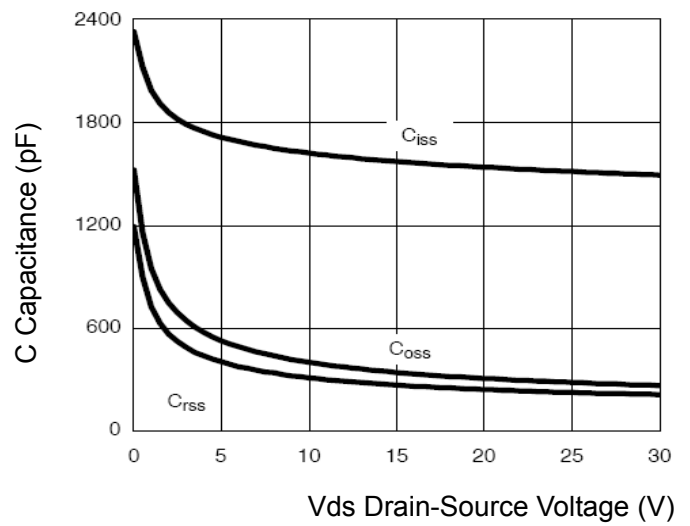

Figure 10 Capacitance vs V_{DS}

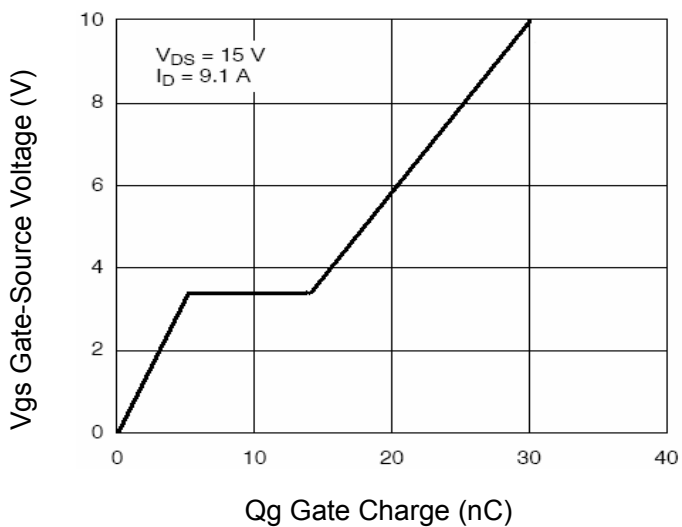

Figure 11 Gate Charge

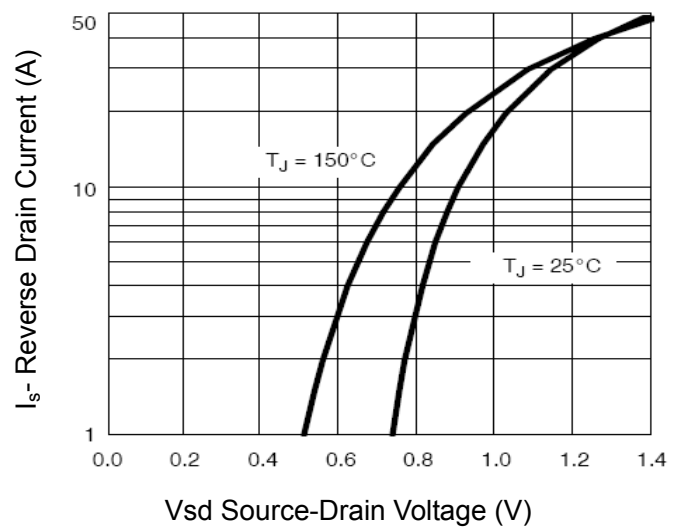

Figure 12 Source-Drain Diode Forward

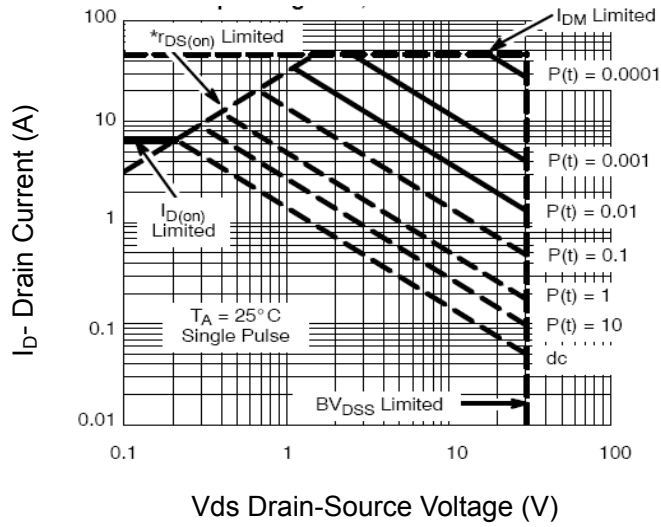

Figure 13 Safe Operation Area

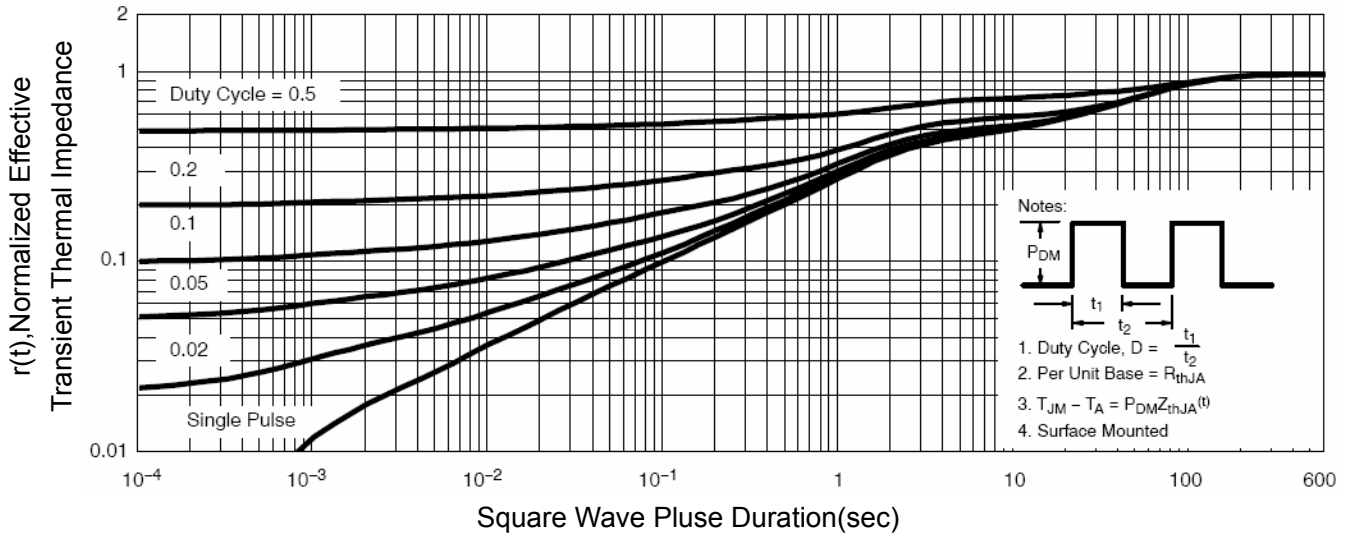
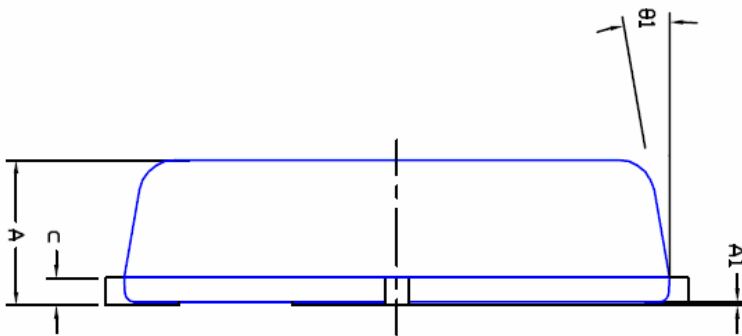
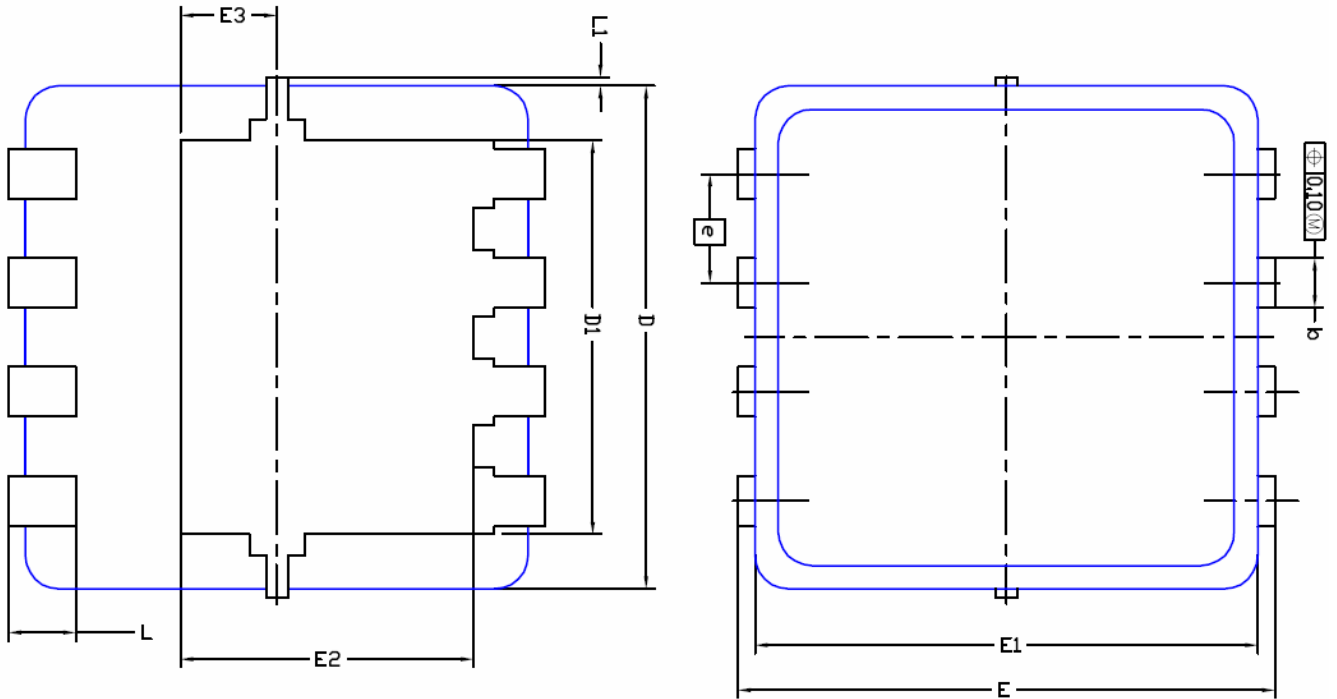

Figure 14 Normalized Maximum Transient Thermal Impedance

DFN3X3 EP Package Information



DIM.	MILLIMETERS			INCHES		
	MIN	NOM	MAX	MIN	NOM	MAX
A	0,700	0,80	0,900	0,0276	0,0315	0,0354
A1	0,00	---	0,05	0,000	---	0,002
b	0,24	0,30	0,35	0,009	0,012	0,014
c	0,10	0,152	0,25	0,004	0,006	0,010
D	3,00 BSC			0,118 BSC		
D1	2,35 BSC			0,093 BSC		
E	3,20 BSC			0,126 BSC		
E1	3,00 BSC			0,118 BSC		
E2	1,75 BSC			0,069 BSC		
E3	0,575 BSC			0,023 BSC		
e	0,65 BSC			0,026 BSC		
L	0,30	0,40	0,50	0,0118	0,0157	0,0197
L1	0	---	0,100	0	---	0,004
θ1	0°	10°	12°	0°	10°	12°