

## N-Channel Enhancement Mode Power MOSFET

### Description

The HM4264A uses advanced trench technology and design to provide excellent  $R_{DS(ON)}$  with low gate charge. It can be used in a wide variety of applications.

### General Features

- $V_{DS} = 60V, I_D = 12.5A$   
 $R_{DS(ON)} < 17m\Omega @ V_{GS}=10V$  (Typ:12.6m $\Omega$ )  
 $R_{DS(ON)} < 22m\Omega @ V_{GS}=4.5V$  (Typ:16m $\Omega$ )
- High density cell design for ultra low Rdson
- Fully characterized avalanche voltage and current
- Low gate to drain charge to reduce switching losses

### Application

- Power switching application
- Load switch

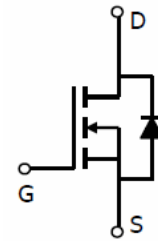

Schematic diagram

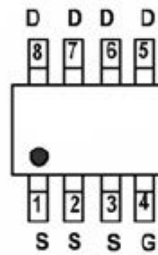

Marking and pin assignment

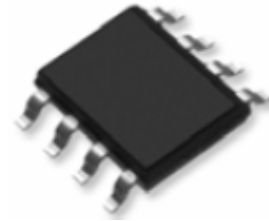

SOP-8 top view

### Package Marking and Ordering Information

Device Marking	Device	Device Package	Reel Size	Tape width	Quantity
HM4264A	HM4264A	SOP-8	Ø330mm	12mm	2500 units

### Absolute Maximum Ratings ( $T_C=25^\circ\text{C}$ unless otherwise noted)

Parameter	Symbol	Limit	Unit
Drain-Source Voltage	$V_{DS}$	60	V
Gate-Source Voltage	$V_{GS}$	$\pm 20$	V
Drain Current-Continuous	$I_D$	12.5	A
Drain Current-Continuous( $T_C=100^\circ\text{C}$ )	$I_D(100^\circ\text{C})$	8.75	A
Pulsed Drain Current	$I_{DM}$	37.5	A
Maximum Power Dissipation	$P_D$	3	W
Operating Junction and Storage Temperature Range	$T_J, T_{STG}$	-55 To 150	$^\circ\text{C}$

### Thermal Characteristic

Thermal Resistance, Junction-to-Ambient <sup>(Note 2)</sup>	$R_{\theta JA}$	42	$^\circ\text{C/W}$
---	-----------------	----	--------------------

**Electrical Characteristics (TC=25°C unless otherwise noted)**

Parameter	Symbol	Condition	Min	Typ	Max	Unit
<b>Off Characteristics</b>						
Drain-Source Breakdown Voltage	$BV_{DSS}$	$V_{GS}=0V, I_D=250\mu A$	60		-	V
Zero Gate Voltage Drain Current	$I_{DSS}$	$V_{DS}=60V, V_{GS}=0V$	-	-	1	$\mu A$
Gate-Body Leakage Current	$I_{GSS}$	$V_{GS}=\pm 20V, V_{DS}=0V$	-	-	$\pm 100$	nA
<b>On Characteristics</b> (Note 3)						
Gate Threshold Voltage	$V_{GS(th)}$	$V_{DS}=V_{GS}, I_D=250\mu A$	1.0	1.5	2.2	V
Drain-Source On-State Resistance	$R_{DS(on)}$	$V_{GS}=10V, I_D=12.5A$	-	12.6	17	m $\Omega$
		$V_{GS}=4.5V, I_D=6A$	-	16	22	m $\Omega$
Forward Transconductance	$g_{FS}$	$V_{DS}=5V, I_D=12.5A$	40	-	-	S
<b>Dynamic Characteristics</b> (Note 4)						
Input Capacitance	$C_{iss}$	$V_{DS}=30V, V_{GS}=0V,$ $F=1.0MHz$	-	4100	-	PF
Output Capacitance	$C_{oss}$		-	298	-	PF
Reverse Transfer Capacitance	$C_{rss}$		-	229	-	PF
<b>Switching Characteristics</b> (Note 4)						
Turn-on Delay Time	$t_{d(on)}$	$V_{DD}=30V, R_L=1\Omega$ $V_{GS}=10V, R_{GEN}=3\Omega$	-	8.5	-	nS
Turn-on Rise Time	$t_r$		-	7	-	nS
Turn-Off Delay Time	$t_{d(off)}$		-	40	-	nS
Turn-Off Fall Time	$t_f$		-	15	-	nS
Total Gate Charge	$Q_g$	$V_{DS}=30V, I_D=12.5A,$ $V_{GS}=10V$	-	93	-	nC
Gate-Source Charge	$Q_{gs}$		-	9.7	-	nC
Gate-Drain Charge	$Q_{gd}$		-	20	-	nC
<b>Drain-Source Diode Characteristics</b>						
Diode Forward Voltage (Note 3)	$V_{SD}$	$V_{GS}=0V, I_S=12.5A$	-	-	1.2	V
Diode Forward Current (Note 2)	$I_S$		-	-	12.5	A
Reverse Recovery Time	$t_{rr}$	$T_J = 25^\circ C, I_F=12.5A$ $di/dt = 100A/\mu s$ (Note 3)	-	32	-	nS
Reverse Recovery Charge	$Q_{rr}$		-	45	-	nC

**Notes:**

1. Repetitive Rating: Pulse width limited by maximum junction temperature.
2. Surface Mounted on FR4 Board,  $t \leq 10$  sec.
3. Pulse Test: Pulse Width  $\leq 300\mu s$ , Duty Cycle  $\leq 2\%$ .
4. Guaranteed by design, not subject to production

Test Circuit

1) E<sub>AS</sub> test Circuit

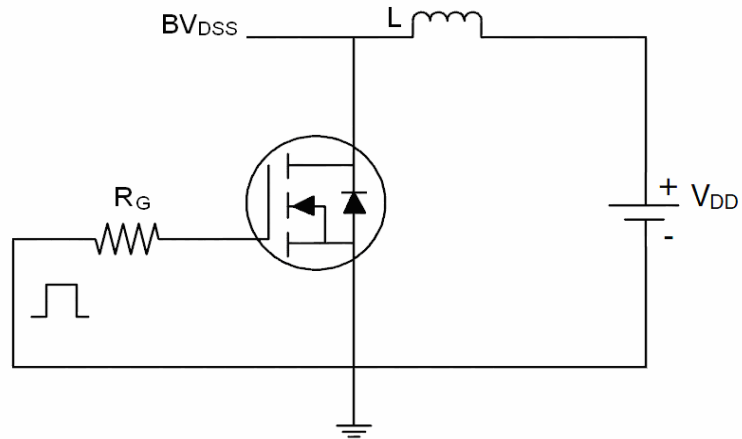

2) Gate charge test Circuit

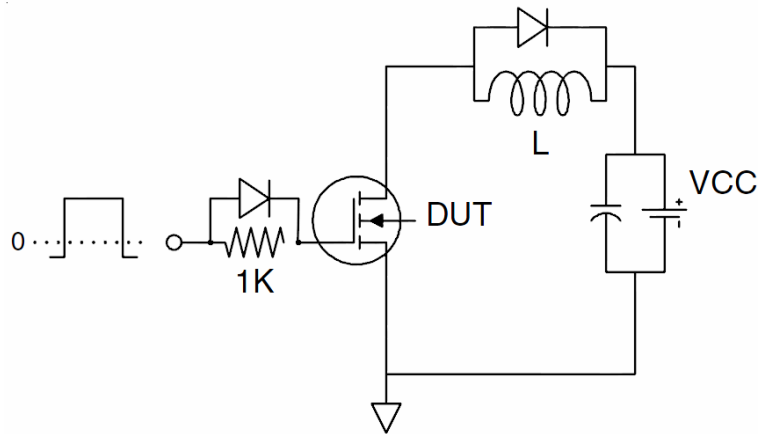

3) Switch Time Test Circuit

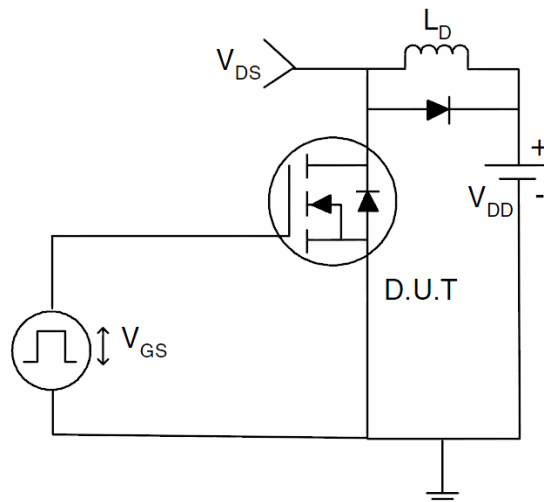

Typical Electrical and Thermal Characteristics (Curves)

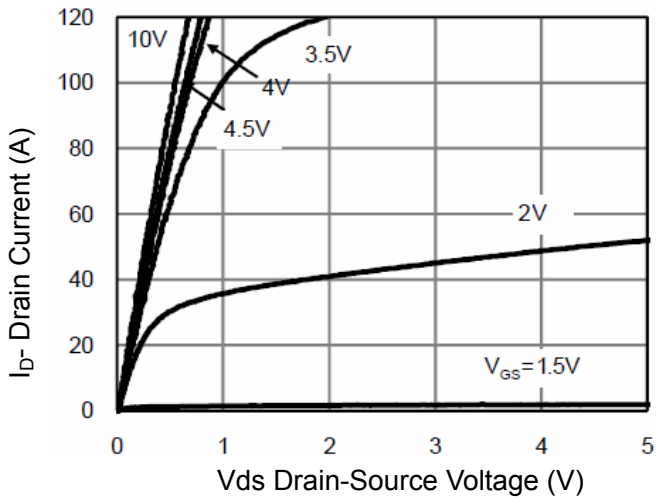

Figure 1 Output Characteristics

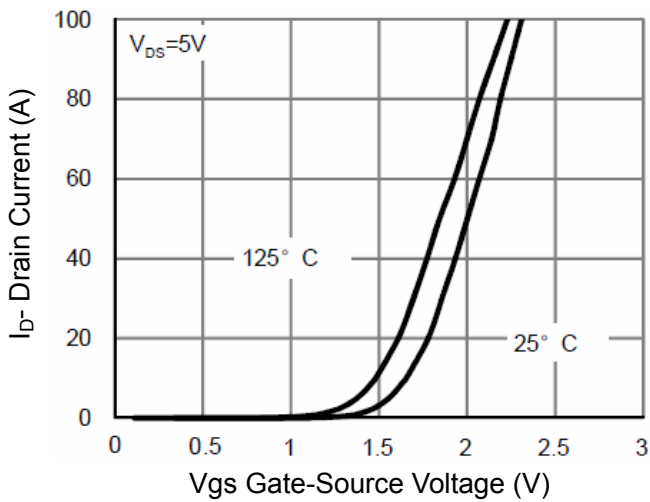

Figure 2 Transfer Characteristics

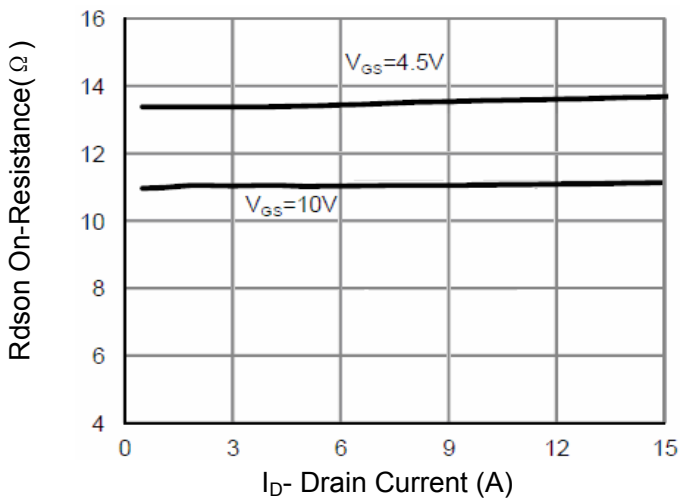

Figure 3  $R_{DS(on)}$ - Drain Current

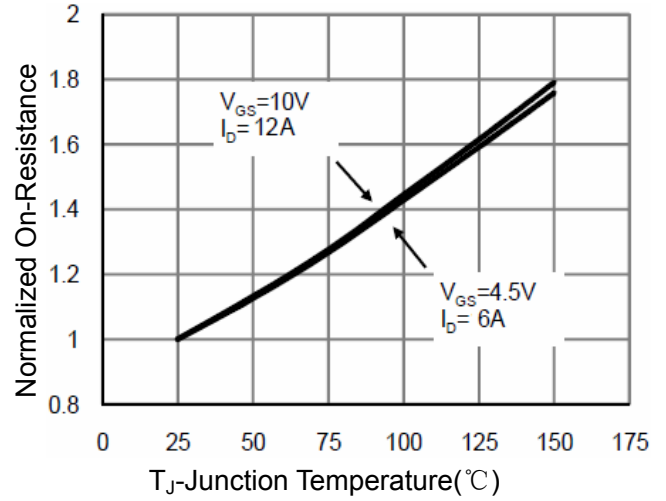

Figure 4  $R_{DS(on)}$ -Junction Temperature

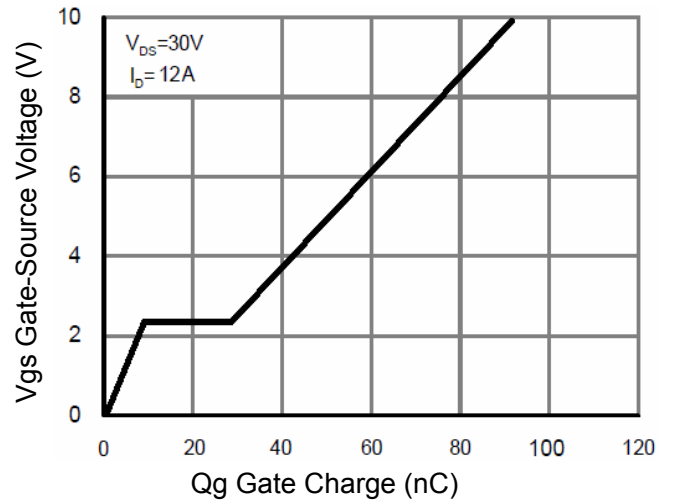

Figure 5 Gate Charge

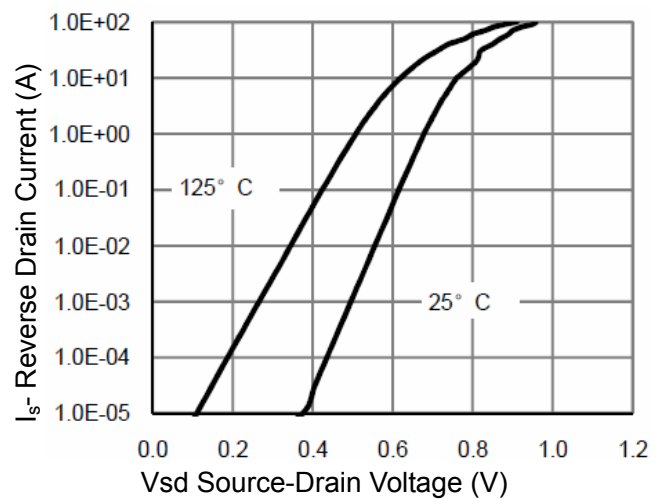

Figure 6 Source- Drain Diode Forward

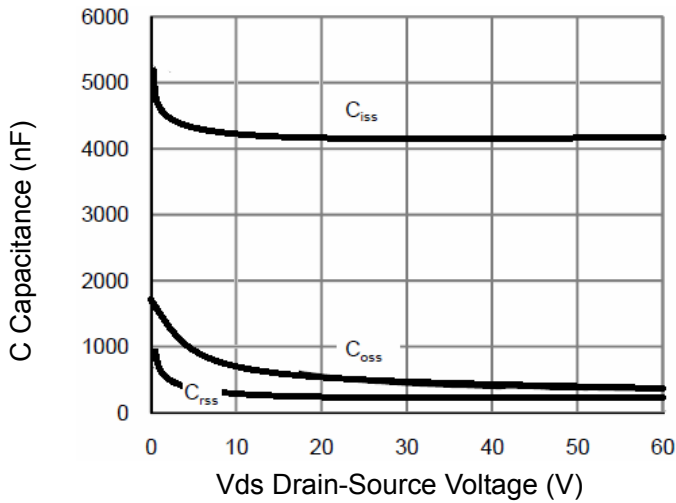

Figure 7 Capacitance vs Vds

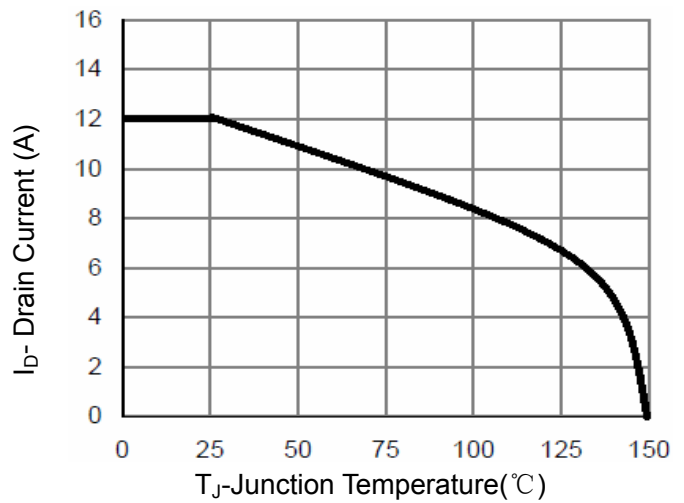

Figure 9 Current De-rating

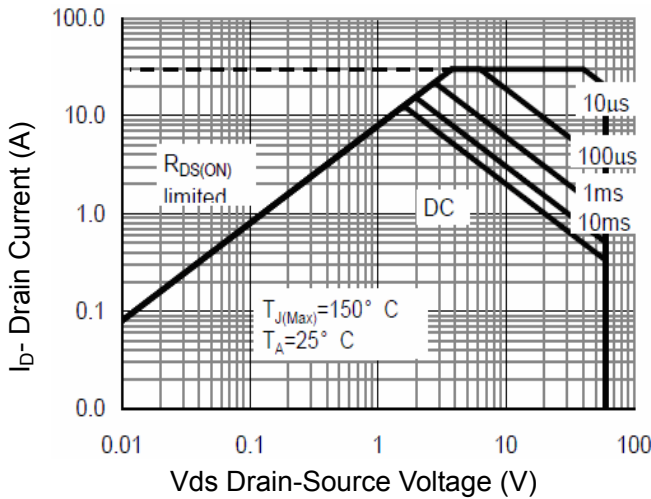

Figure 8 Safe Operation Area

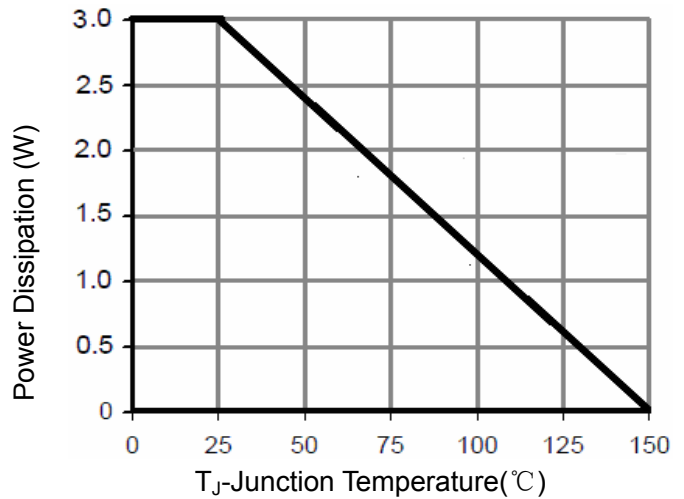

Figure 10 Power De-rating

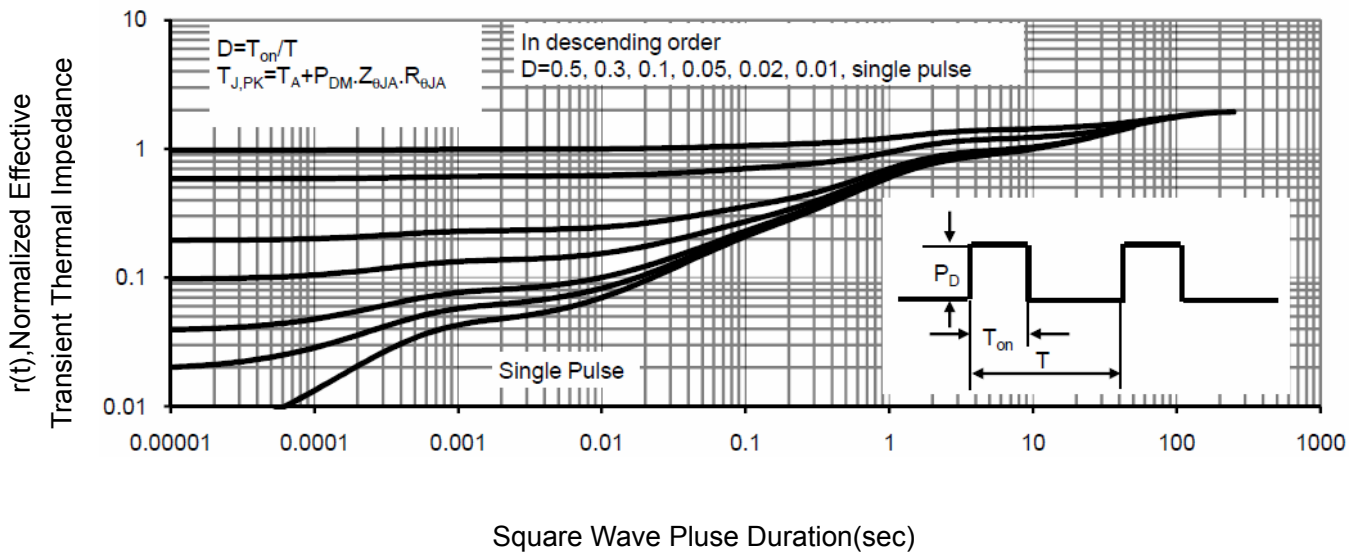
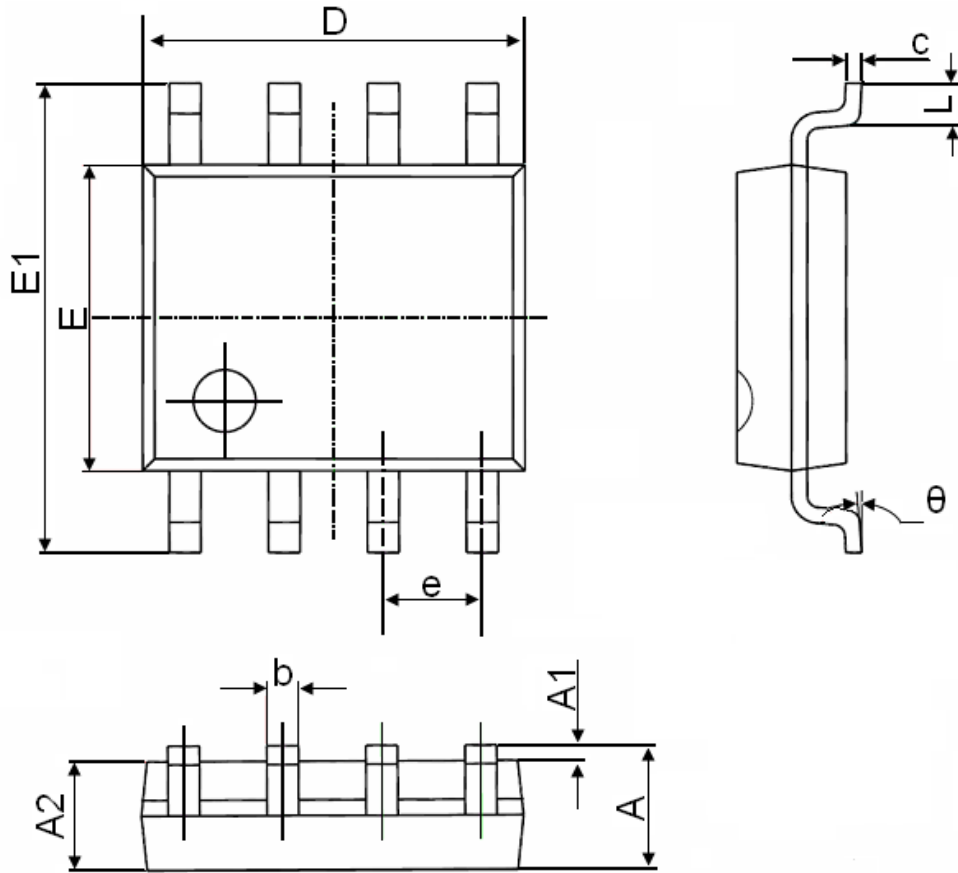

Figure 11 Normalized Maximum Transient Thermal Impedance

SOP-8 Package Information



Symbol	Dimensions In Millimeters		Dimensions In Inches	
	Min.	Max.	Min.	Max.
A	1.350	1.750	0.053	0.069
A1	0.100	0.250	0.004	0.010
A2	1.350	1.550	0.053	0.061
b	0.330	0.510	0.013	0.020
c	0.170	0.250	0.006	0.010
D	4.700	5.100	0.185	0.200
E	3.800	4.000	0.150	0.157
E1	5.800	6.200	0.228	0.244
e	1.270(BSC)		0.050(BSC)	
L	0.400	1.270	0.016	0.050
$\theta$	0°	8°	0°	8°