

## N and P-Channel Enhancement Mode Power MOSFET

### Description

The HM4618 uses advanced trench technology to provide excellent  $R_{DS(ON)}$  and low gate charge. The complementary MOSFETs may be used to form a level shifted high side switch, and for a host of other applications.

### General Features

#### ● N-Channel

$$V_{DS} = 40V, I_D = 10A$$

$$R_{DS(ON)} < 24m\Omega @ V_{GS}=10V$$

$$R_{DS(ON)} < 35m\Omega @ V_{GS}=4.5V$$

#### ● P-Channel

$$V_{DS} = -40V, I_D = -7.5A$$

$$R_{DS(ON)} < 42m\Omega @ V_{GS}=-10V$$

$$R_{DS(ON)} < 70m\Omega @ V_{GS}=-4.5V$$

- High power and current handling capability
- Lead free product is acquired
- Surface mount package

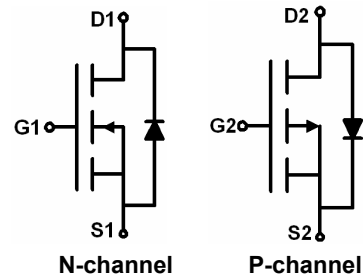

Schematic diagram

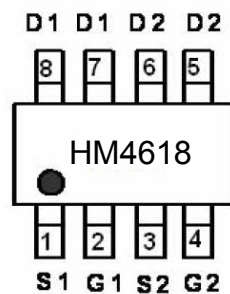

Marking and pin assignment

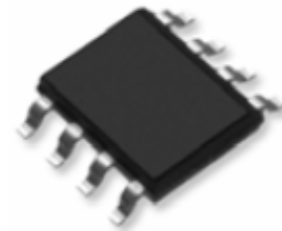

SOP-8 top view

### Package Marking and Ordering Information

Device Marking	Device	Device Package	Reel Size	Tape width	Quantity
HM4618	HM4618	SOP-8	Ø330mm	12mm	2500 units

### Absolute Maximum Ratings ( $T_A=25^\circ\text{C}$ unless otherwise noted)

Parameter	Symbol	N-Channel	P-Channel	Unit
Drain-Source Voltage	$V_{DS}$	40	-40	V
Gate-Source Voltage	$V_{GS}$	$\pm 20$	$\pm 20$	V
Continuous Drain Current	$I_D$	$T_A=25^\circ\text{C}$	10	-7.5
		$T_A=70^\circ\text{C}$	8.0	-6.0
Pulsed Drain Current <sup>(Note 1)</sup>	$I_{DM}$	40	-30	A
Maximum Power Dissipation	$P_D$	2.0	2.0	W
Operating Junction and Storage Temperature Range	$T_J, T_{STG}$	-55 To 150	-55 To 150	$^\circ\text{C}$

### Thermal Characteristic

Thermal Resistance, Junction-to-Ambient <sup>(Note2)</sup>	$R_{\theta JA}$	N-Ch	62.5	$^{\circ}C/W$
Thermal Resistance, Junction-to-Ambient <sup>(Note2)</sup>	$R_{\theta JA}$	P-Ch	62.5	$^{\circ}C/W$

**N-CH Electrical Characteristics ( $T_A=25^{\circ}C$  unless otherwise noted)**

Parameter	Symbol	Condition	Min	Typ	Max	Unit
<b>Off Characteristics</b>						
Drain-Source Breakdown Voltage	$BV_{DSS}$	$V_{GS}=0V, I_D=250\mu A$	40	-	-	V
Zero Gate Voltage Drain Current	$I_{DSS}$	$V_{DS}=40V, V_{GS}=0V$	-	-	1	$\mu A$
Gate-Body Leakage Current	$I_{GSS}$	$V_{GS}=\pm 10V, V_{DS}=0V$	-	-	$\pm 10$	$\mu A$
<b>On Characteristics</b> <sup>(Note 3)</sup>						
Gate Threshold Voltage	$V_{GS(th)}$	$V_{DS}=V_{GS}, I_D=250\mu A$	1	1.6	3	V
Drain-Source On-State Resistance	$R_{DS(on)}$	$V_{GS}=10V, I_D=10A$	-	16	24	m $\Omega$
		$V_{GS}=4.5V, I_D=5A$	-	25	35	m $\Omega$
Forward Transconductance	$g_{FS}$	$V_{DS}=5V, I_D=10A$	15	-	-	S
<b>Dynamic Characteristics</b> <sup>(Note4)</sup>						
Input Capacitance	$C_{iss}$	$V_{DS}=20V, V_{GS}=0V,$ $F=1.0MHz$	-	516	-	PF
Output Capacitance	$C_{oss}$		-	82	-	PF
Reverse Transfer Capacitance	$C_{rss}$		-	43	-	PF
<b>Switching Characteristics</b> <sup>(Note 4)</sup>						
Turn-on Delay Time	$t_{d(on)}$	$V_{DD}=15V, R_L=2.5\Omega$ $V_{GS}=10V, R_{GEN}=3\Omega$	-	4.5	-	nS
Turn-on Rise Time	$t_r$		-	2.5	-	nS
Turn-Off Delay Time	$t_{d(off)}$		-	14.5	-	nS
Turn-Off Fall Time	$t_f$		-	3.5	-	nS
Total Gate Charge	$Q_g$	$V_{DS}=20V, I_D=10A,$ $V_{GS}=10V$	-	8.9	-	nC
Gate-Source Charge	$Q_{gs}$		-	2.4	-	nC
Gate-Drain Charge	$Q_{gd}$		-	1.4	-	nC
<b>Drain-Source Diode Characteristics</b>						
Diode Forward Voltage <sup>(Note 3)</sup>	$V_{SD}$	$V_{GS}=0V, I_S=10A$	-	0.8	1.2	V

**P-CH Electrical Characteristics ( $T_A=25^{\circ}\text{C}$  unless otherwise noted)**

Parameter	Symbol	Condition	Min	Typ	Max	Unit
<b>Off Characteristics</b>						
Drain-Source Breakdown Voltage	$BV_{DSS}$	$V_{GS}=0V, I_D=-250\mu A$	-40	-	-	V
Zero Gate Voltage Drain Current	$I_{DSS}$	$V_{DS}=-40V, V_{GS}=0V$	-	-	-1	$\mu A$
Gate-Body Leakage Current	$I_{GSS}$	$V_{GS}=\pm 10V, V_{DS}=0V$	-	-	$\pm 10$	$\mu A$
<b>On Characteristics (Note 3)</b>						
Gate Threshold Voltage	$V_{GS(th)}$	$V_{DS}=V_{GS}, I_D=-250\mu A$	-1.0	-2.0	-3.0	V
Drain-Source On-State Resistance	$R_{DS(ON)}$	$V_{GS}=-10V, I_D=-7.5A$	-	30	42	$m\Omega$
		$V_{GS}=-4.5V, I_D=-5A$	-	49	70	$m\Omega$
Forward Transconductance	$g_{FS}$	$V_{DS}=-5V, I_D=-5A$	10	-	-	S
<b>Dynamic Characteristics (Note4)</b>						
Input Capacitance	$C_{iss}$	$V_{DS}=-20V, V_{GS}=0V,$ $F=1.0MHz$	-	940	-	PF
Output Capacitance	$C_{oss}$		-	97	-	PF
Reverse Transfer Capacitance	$C_{rss}$		-	72	-	PF
<b>Switching Characteristics (Note 4)</b>						
Turn-on Delay Time	$t_{d(on)}$	$V_{DD}=-20V, R_L=2.3\Omega$ $V_{GS}=-10V, R_{GEN}=6\Omega$	-	6.2	-	nS
Turn-on Rise Time	$t_r$		-	8.4	-	nS
Turn-Off Delay Time	$t_{d(off)}$		-	44.8	-	nS
Turn-Off Fall Time	$t_f$		-	16	-	nS
Total Gate Charge	$Q_g$	$V_{DS}=-20V, I_D=-7.5A$ $V_{GS}=-10V$	-	17	-	nC
Gate-Source Charge	$Q_{gs}$		-	3.4	-	nC
Gate-Drain Charge	$Q_{gd}$		-	3.2	-	nC
<b>Drain-Source Diode Characteristics</b>						
Diode Forward Voltage (Note 3)	$V_{SD}$	$V_{GS}=0V, I_S=-7.5A$	-	-	-1.2	V

**Notes:**

1. Repetitive Rating: Pulse width limited by maximum junction temperature.
2. Surface Mounted on FR4 Board,  $t \leq 10$  sec.
3. Pulse Test: Pulse Width  $\leq 300\mu s$ , Duty Cycle  $\leq 2\%$ .
4. Guaranteed by design, not subject to production

N- Channel Typical Electrical and Thermal Characteristics (Curves)

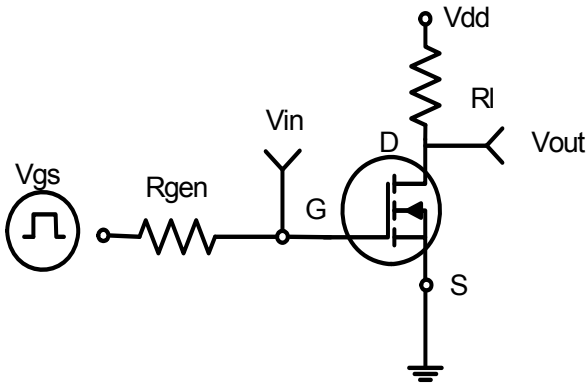

Figure 1: Switching Test Circuit

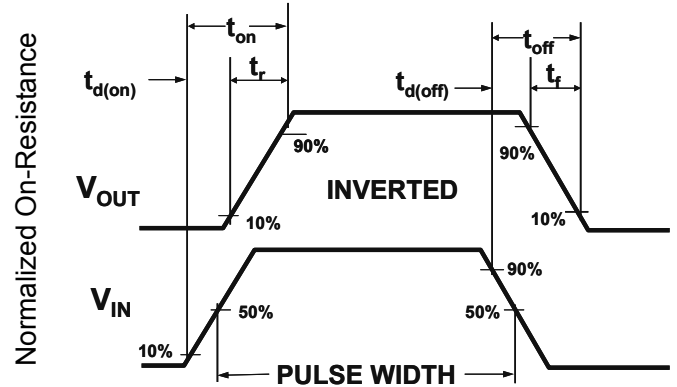

Figure 2: Switching Waveforms

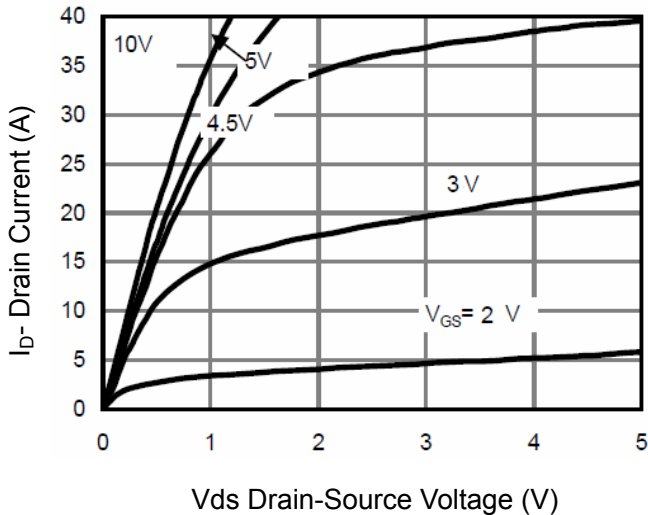

Figure 3 Output Characteristics

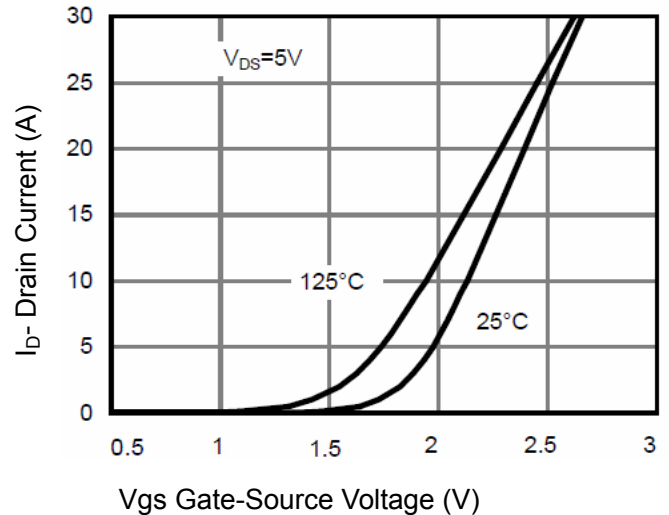

Figure 4 Transfer Characteristics

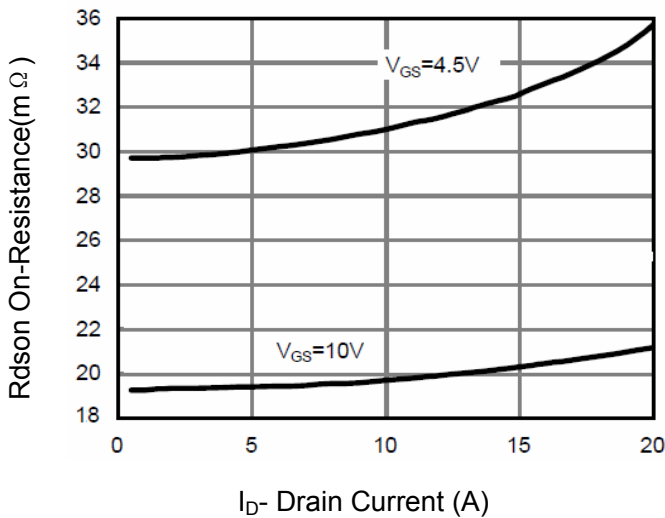

Figure 5 Drain-Source On-Resistance

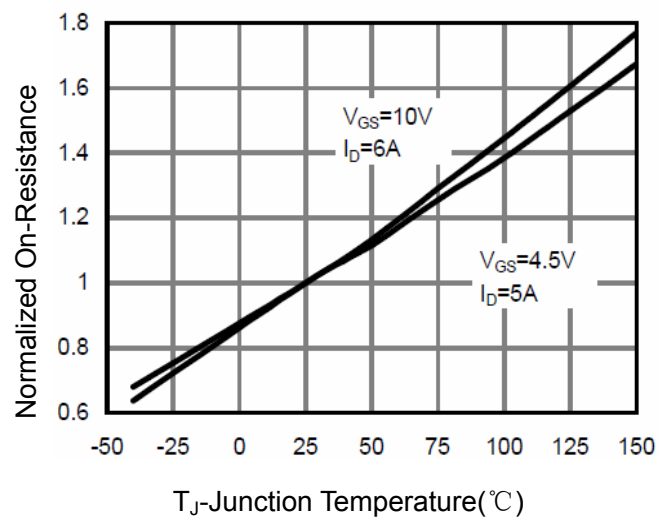
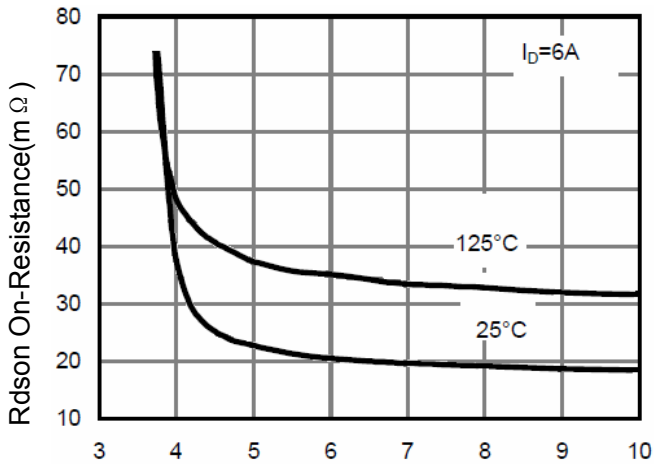
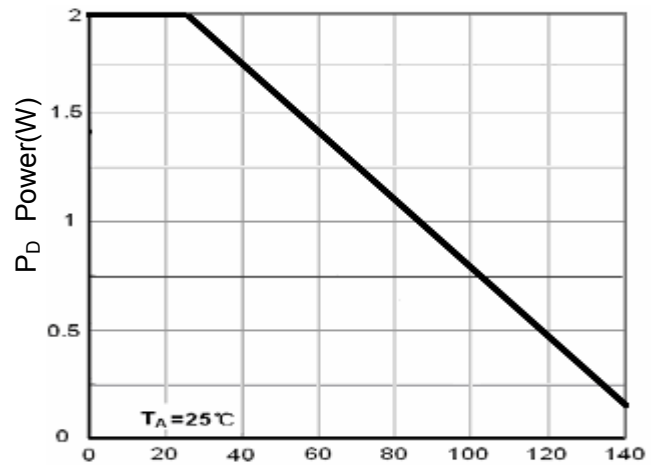

Figure 6 Drain-Source On-Resistance



Vgs Gate-Source Voltage (V)  
**Figure 7 Rdson vs Vgs**



T<sub>J</sub>-Junction Temperature(°C)  
**Figure 8 Power Dissipation**

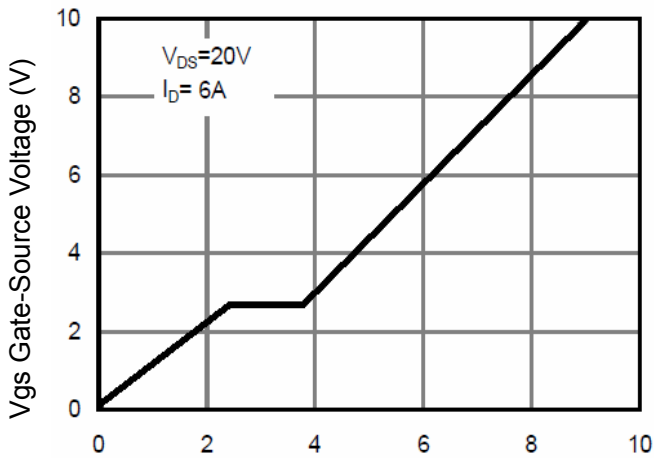

Qg Gate Charge (nC)  
**Figure 9 Gate Charge**

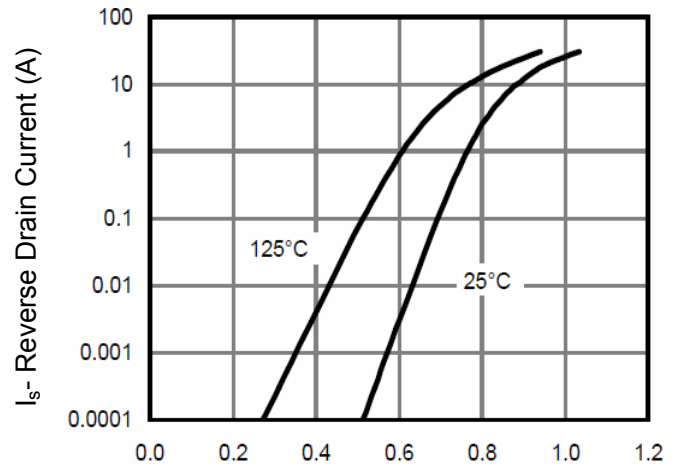

Vds Drain-Source Voltage (V)  
**Figure 10 Source- Drain Diode Forward**

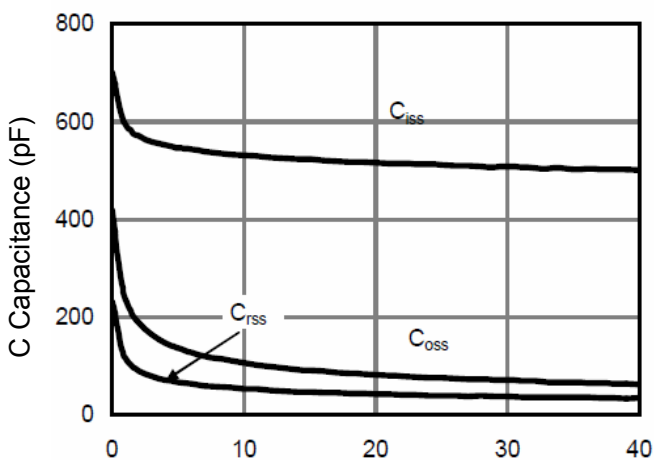

Vds Drain-Source Voltage (V)  
**Figure 11 Capacitance vs Vds**

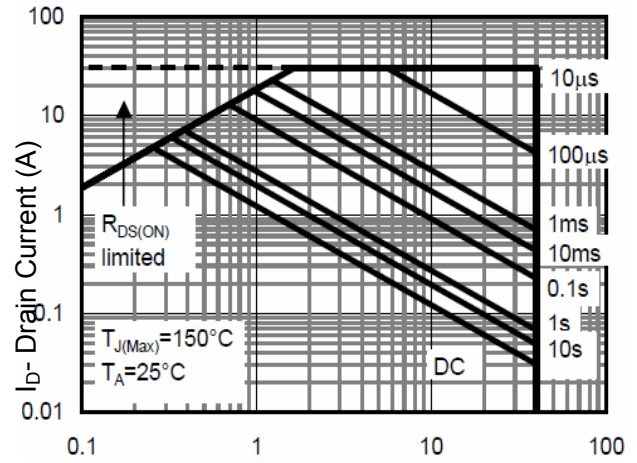

Vds Drain-Source Voltage (V)  
**Figure 12 Safe Operation Area**

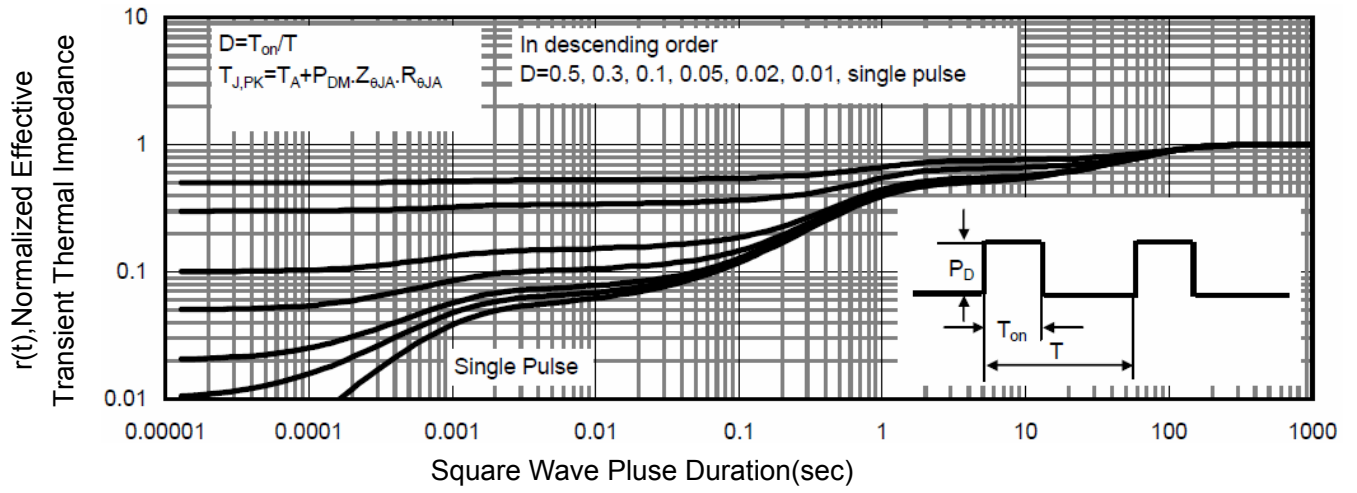

Figure 13 Normalized Maximum Transient Thermal Impedance

P- Channel Typical Electrical and Thermal Characteristics (Curves)

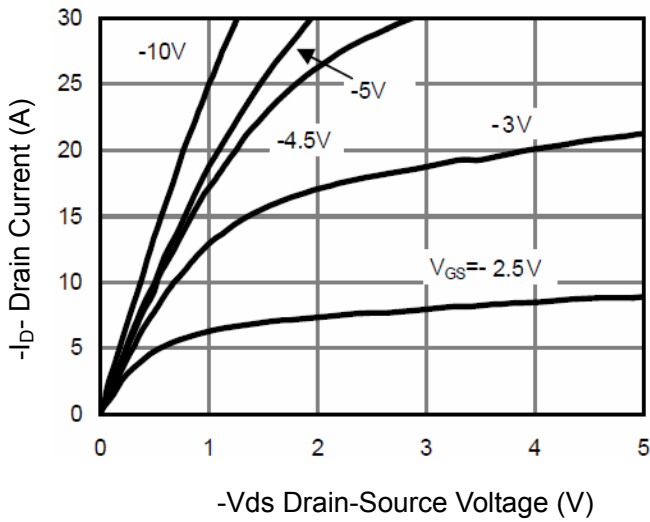

Figure 1 Output Characteristics

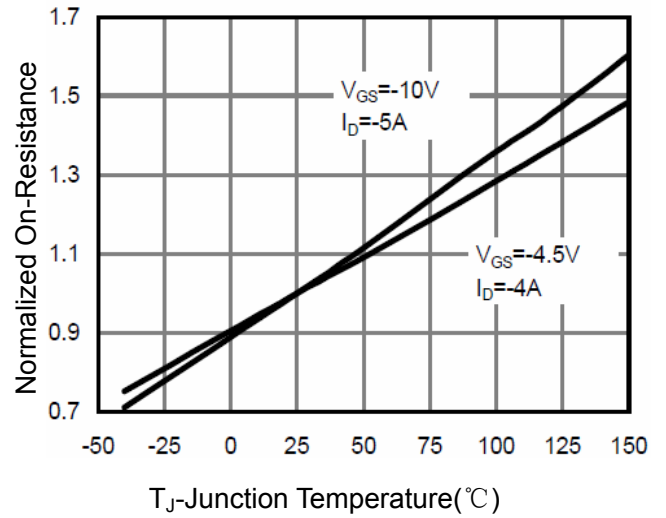

Figure 4 Rdson-Junction Temperature

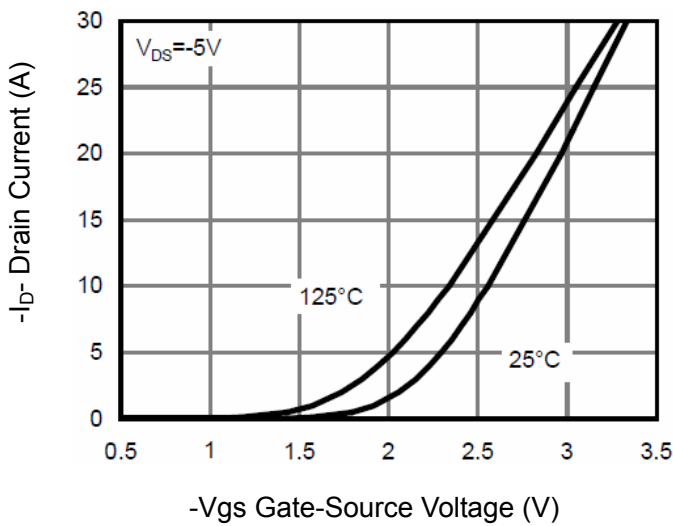

Figure 2 Transfer Characteristics

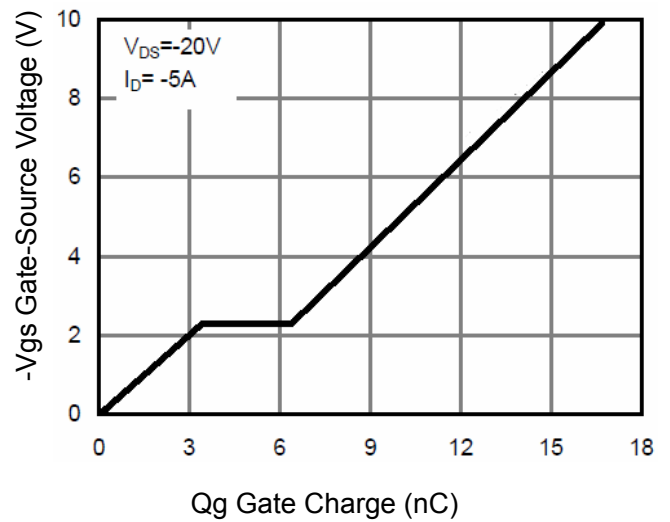

Figure 5 Gate Charge

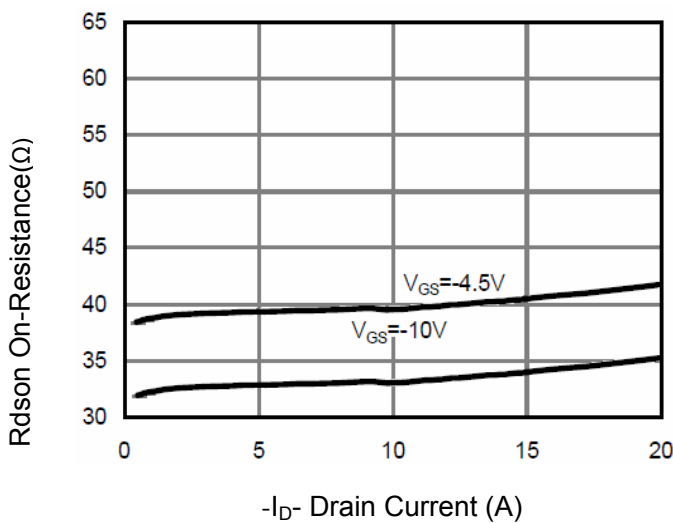

Figure 3 Rdson- Drain Current

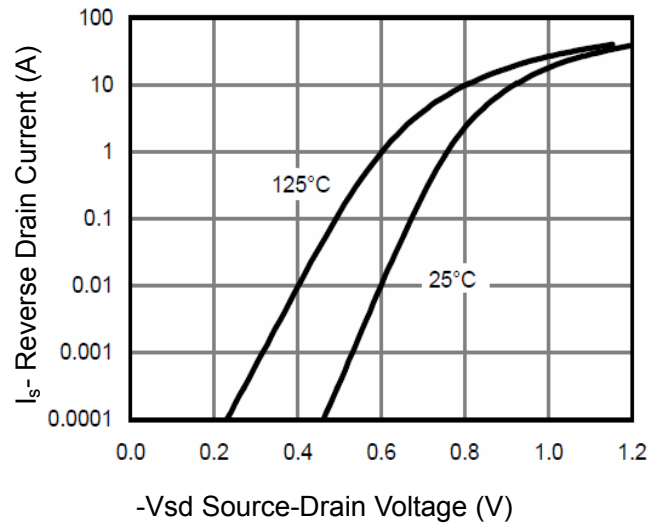
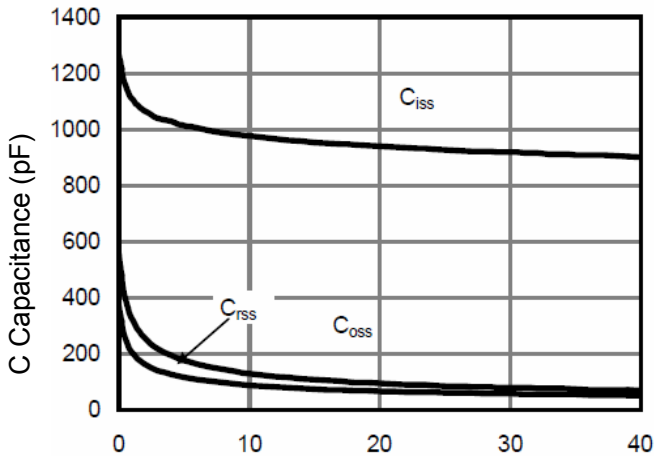
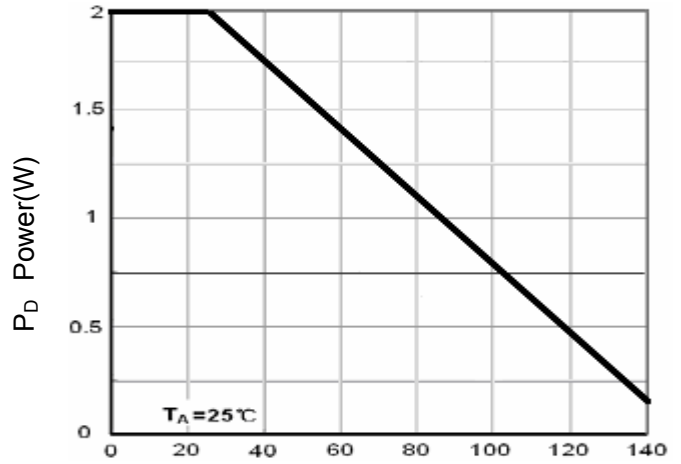

Figure 6 Source- Drain Diode Forward



-Vds Drain-Source Voltage (V)  
**Figure 7 Capacitance vs Vds**



$T_J$ -Junction Temperature(°C)  
**Figure 9 Power Dissipation**

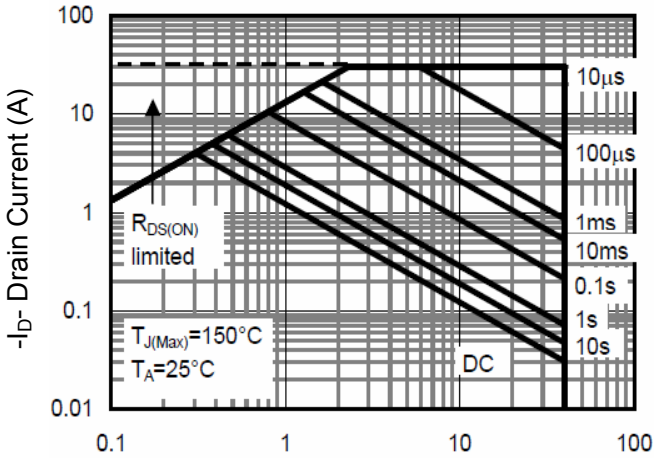

-Vds Drain-Source Voltage (V)  
**Figure 8 Safe Operation Area**

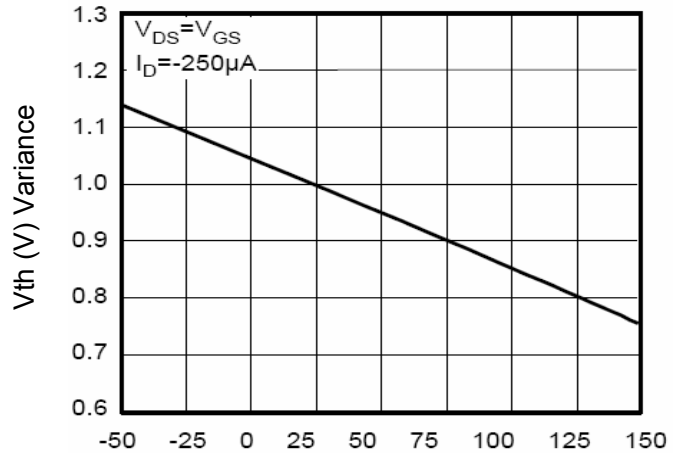

$T_J$ -Junction Temperature(°C)  
**Figure 10  $V_{GS(th)}$  vs Junction Temperature**

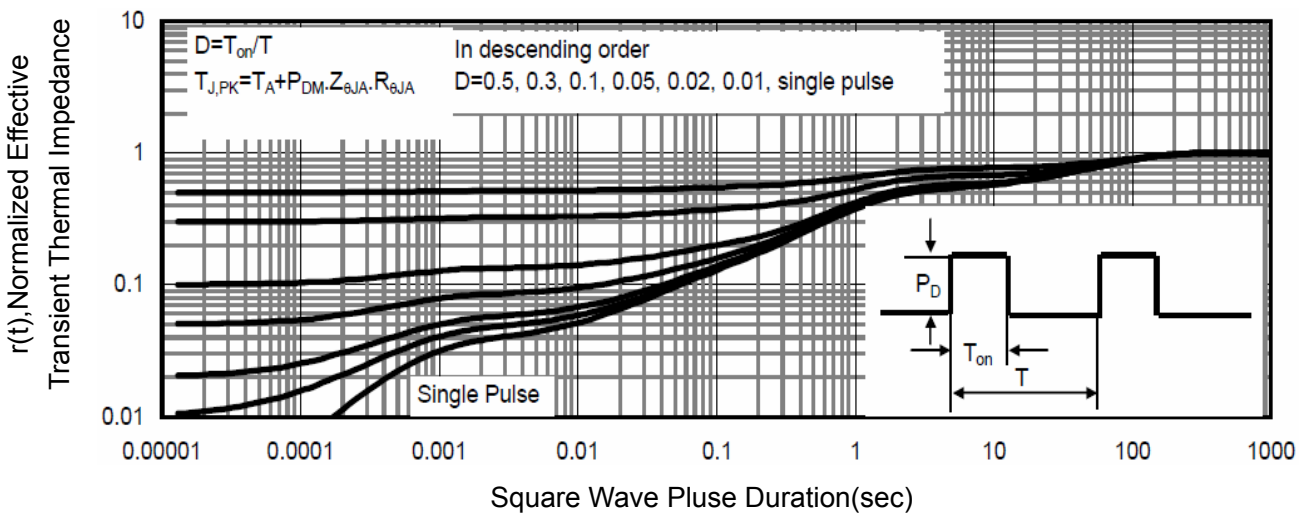

**Figure 11 Normalized Maximum Transient Thermal Impedance**



SOP-8 Package Information

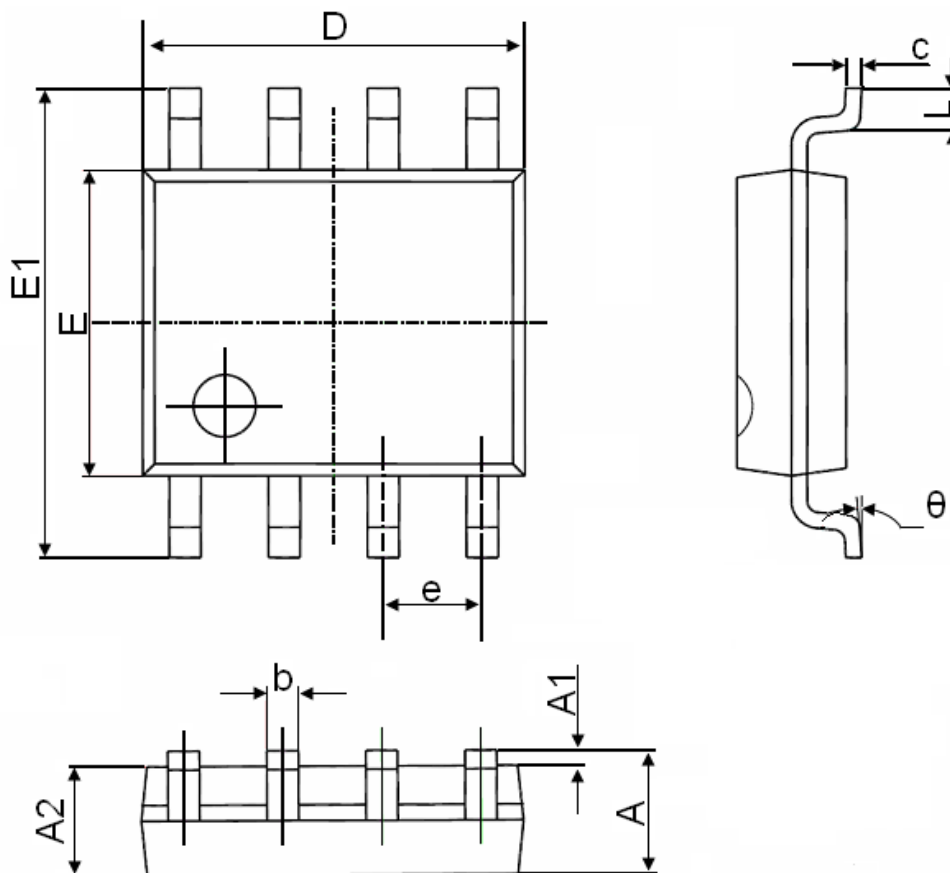

Symbol	Dimensions In Millimeters		Dimensions In Inches	
	Min.	Max.	Min.	Max.
A	1.350	1.750	0.053	0.069
A1	0.100	0.250	0.004	0.010
A2	1.350	1.550	0.053	0.061
b	0.330	0.510	0.013	0.020
c	0.170	0.250	0.006	0.010
D	4.700	5.100	0.185	0.200
E	3.800	4.000	0.150	0.157
E1	5.800	6.200	0.228	0.244
e	1.270(BSC)		0.050(BSC)	
L	0.400	1.270	0.016	0.050
theta	0°	8°	0°	8°