

## N&P-Channel V Complementary MOSFET

### Description

The HM605K uses advanced trench technology and design to provide excellent  $R_{DS(ON)}$  with low gate charge. It can be used in a wide variety of applications.

### General Features

#### N channel

- $V_{DS} = 0V, I_D = 1.5A$   
 $R_{DS(ON)} < 7m\Omega @ V_{GS} = 10V$   
 $R_{DS(ON)} < 8m\Omega @ V_{GS} = 4.5V$

#### p channel

- $V_{DS} = -0V, I_D = -35A$   
 $R_{DS(ON)} < 12m\Omega @ V_{GS} = -10V$   
 $R_{DS(ON)} < 16m\Omega @ V_{GS} = -4.5V$
- High density cell design for ultra low  $R_{dson}$
- Fully characterized avalanche voltage and current
- Good stability and uniformity with high  $E_{AS}$
- Excellent package for good heat dissipation
- Special process technology for high ESD capability

### Application

- H-bridge
- Inverters

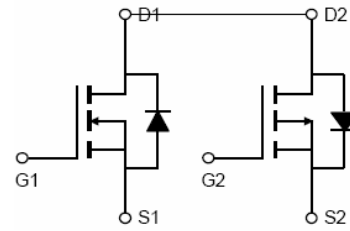

Schematic diagram



Marking and pin assignment

**100% UIS TESTED!**

**100%  $\Delta V_{ds}$  TESTED!**

### Package Marking and Ordering Information

Device Marking	Device	Device Package	Reel Size	Tape width	Quantity
HM605K	HM605K	TO-252-4L	-	-	-

### Absolute Maximum Ratings ( $T_C = 25^\circ C$ unless otherwise noted)

Parameter	Symbol	N-Channel	P-Channel	Unit	
Drain-Source Voltage	$V_{DS}$	0	-0	V	
Gate-Source Voltage	$V_{GS}$	$\pm 20$	$\pm 20$	V	
Continuous Drain Current	$I_D$	$T_C = 25^\circ C$	1.5	-35	A
		$T_C = 100^\circ C$	31.5	-24.5	A
Pulsed Drain Current <sup>(Note 1)</sup>	$I_{DM}$	135	-105	A	
Maximum Power Dissipation	$P_D$	21		W	
Operating Junction and Storage Temperature Range	$T_J, T_{STG}$	-55 To 175		$^\circ C$	

### Thermal Characteristic

Thermal Resistance, Junction-to-Case <sup>(Note 2)</sup>	$R_{\theta JC}$	7	$^\circ C/W$
--	-----------------	---	--------------

**N-Channel Electrical Characteristics (T<sub>C</sub>=25°C unless otherwise noted)**

Parameter	Symbol	Condition	Min	Typ	Max	Unit
<b>Off Characteristics</b>						
Drain-Source Breakdown Voltage	BV <sub>DSS</sub>	V <sub>GS</sub> =0V, I <sub>D</sub> =250μA	∅	-	-	V
Zero Gate Voltage Drain Current	I <sub>DSS</sub>	V <sub>DS</sub> =∅V, V <sub>GS</sub> =0V	-	-	1	μA
Gate-Body Leakage Current	I <sub>GSS</sub>	V <sub>GS</sub> =±20V, V <sub>DS</sub> =0V	-	-	±100	nA
<b>On Characteristics</b> (Note 3)						
Gate Threshold Voltage	V <sub>GS(th)</sub>	V <sub>DS</sub> =V <sub>GS</sub> , I <sub>D</sub> =250μA	0.4	-	1.2	V
Drain-Source On-State Resistance	R <sub>DS(on)</sub>	V <sub>GS</sub> =10V, I <sub>D</sub> =7A	-	4	7	mΩ
		V <sub>GS</sub> =4.5V, I <sub>D</sub> =6A	-	5	8	mΩ
Forward Transconductance	g <sub>FS</sub>	V <sub>DS</sub> =10V, I <sub>D</sub> =7A	-	29	-	S
<b>Dynamic Characteristics</b> (Note 4)						
Input Capacitance	C <sub>iss</sub>	V <sub>DS</sub> =15V, V <sub>GS</sub> =0V, F=1.0MHz	-	450	-	PF
Output Capacitance	C <sub>oss</sub>		-	150	-	PF
Reverse Transfer Capacitance	C <sub>rss</sub>		-	90	-	PF
<b>Switching Characteristics</b> (Note 4)						
Turn-on Delay Time	t <sub>d(on)</sub>	V <sub>DD</sub> =15V, R <sub>L</sub> =2.5Ω V <sub>GS</sub> =10V, R <sub>G</sub> =3Ω	-	5	-	nS
Turn-on Rise Time	t <sub>r</sub>		-	12	-	nS
Turn-Off Delay Time	t <sub>d(off)</sub>		-	19	-	nS
Turn-Off Fall Time	t <sub>f</sub>		-	6	-	nS
Total Gate Charge	Q <sub>g</sub>	V <sub>DS</sub> =15V, I <sub>D</sub> =6A, V <sub>GS</sub> =10V	-	9.5	-	nC
Gate-Source Charge	Q <sub>gs</sub>		-	2.0	-	nC
Gate-Drain Charge	Q <sub>gd</sub>		-	1.9	-	nC
<b>Drain-Source Diode Characteristics</b>						
Diode Forward Voltage (Note 3)	V <sub>SD</sub>	V <sub>GS</sub> =0V, I <sub>S</sub> =45A	-	-	1.2	V
Diode Forward Current (Note 2)	I <sub>S</sub>		-	-	45	A

**Notes:**

1. Repetitive Rating: Pulse width limited by maximum junction temperature.
2. Surface Mounted on FR4 Board, t ≤ 10 sec.
3. Pulse Test: Pulse Width ≤ 300μs, Duty Cycle ≤ 2%.
4. Guaranteed by design, not subject to production
5. EAS condition: T<sub>J</sub>=25°C, V<sub>DD</sub>=∅V, V<sub>G</sub>=10V, L=0.5mH, R<sub>G</sub>=25Ω

N-Channel Typical Electrical and Thermal Characteristics (Curves)

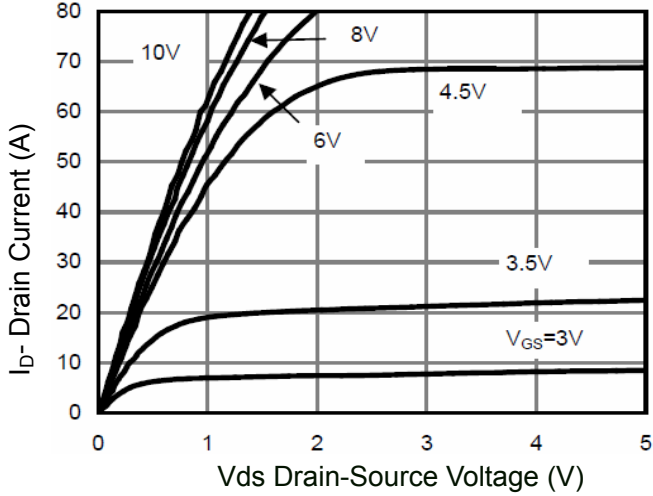

Figure 1 Output Characteristics

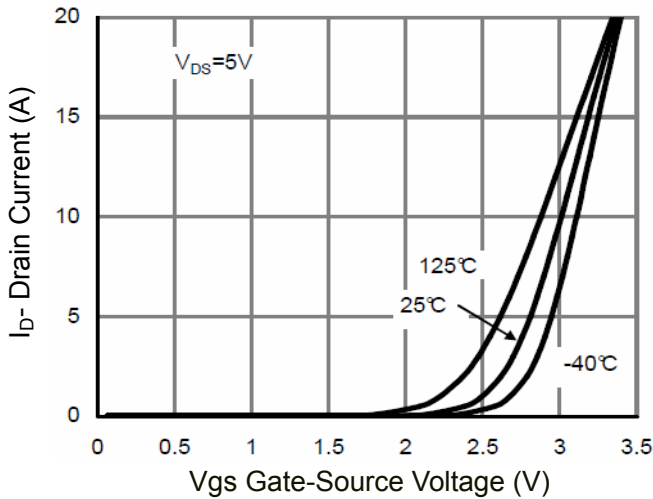

Figure 2 Transfer Characteristics

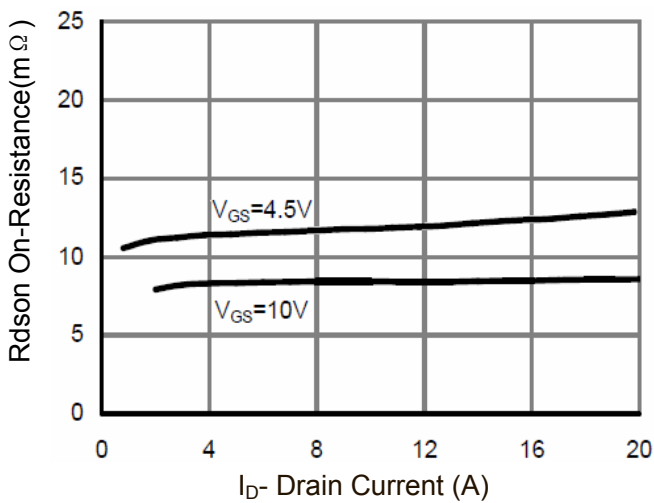

Figure 3 Rdson- Drain Current

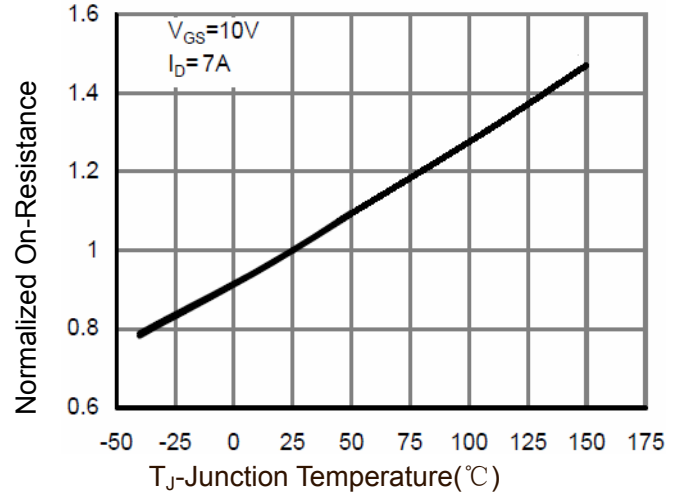

Figure 4 Rdson-Junction Temperature

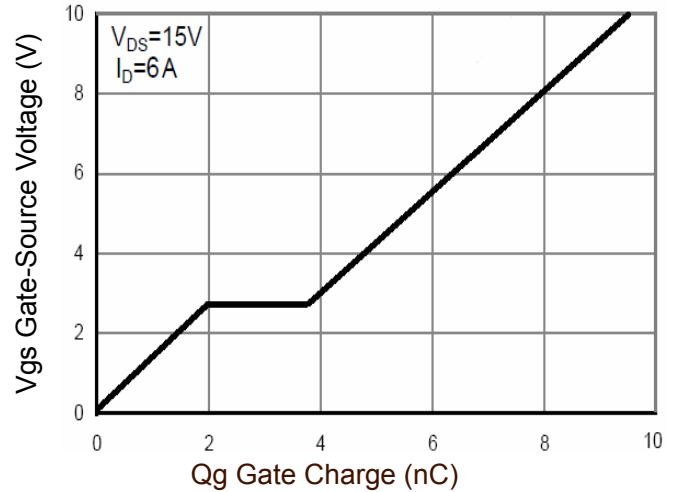

Figure 5 Gate Charge

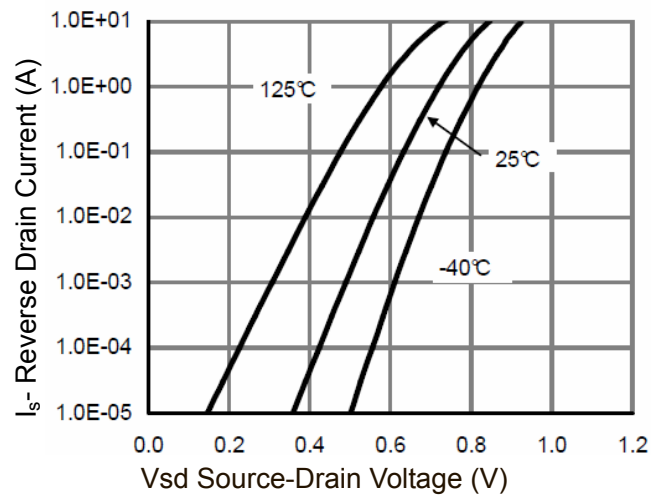

Figure 6 Source- Drain Diode Forward

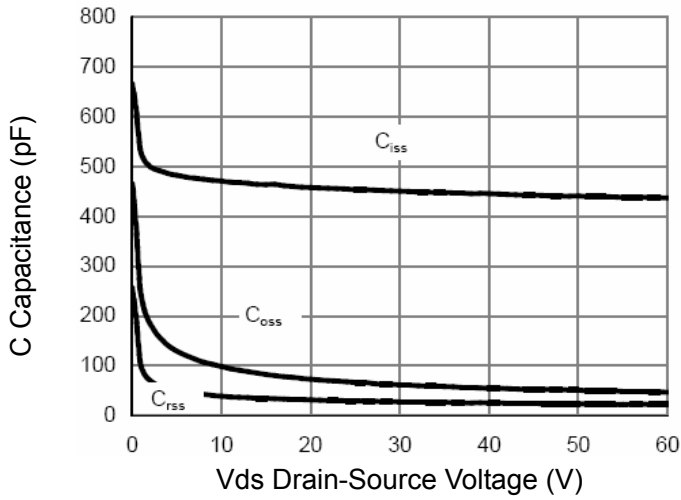

Figure 7 Capacitance vs Vds

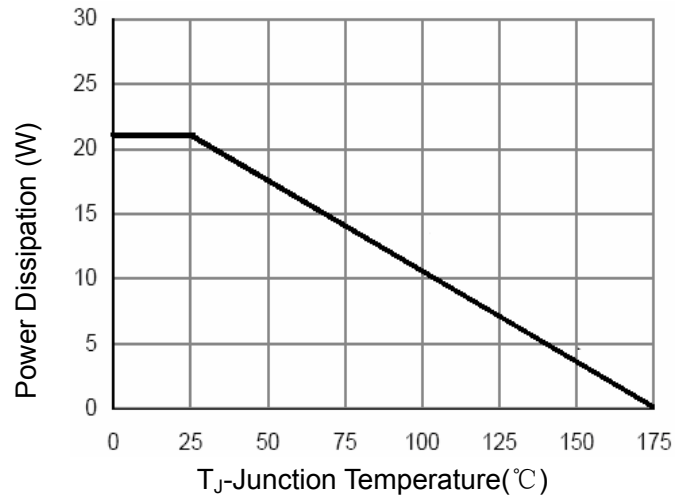

Figure 9 Power De-rating

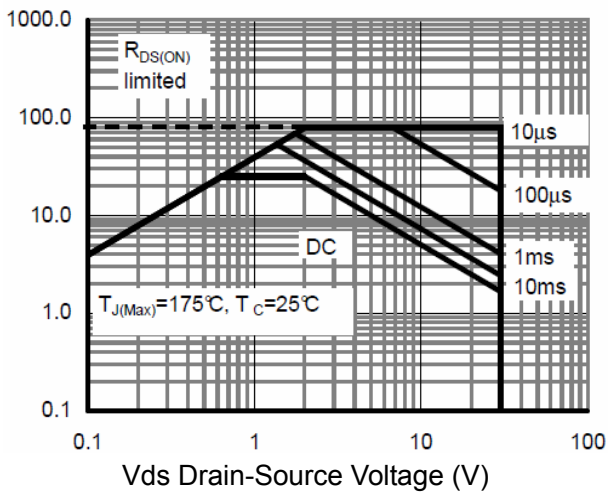

Figure 8 Safe Operation Area

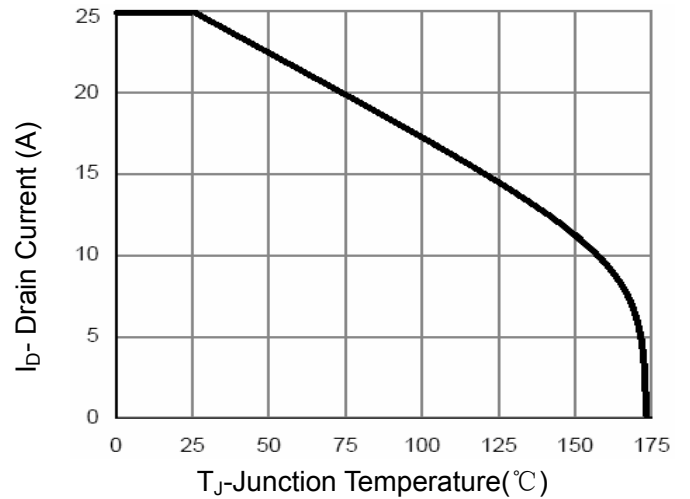

Figure 10 Current De-rating

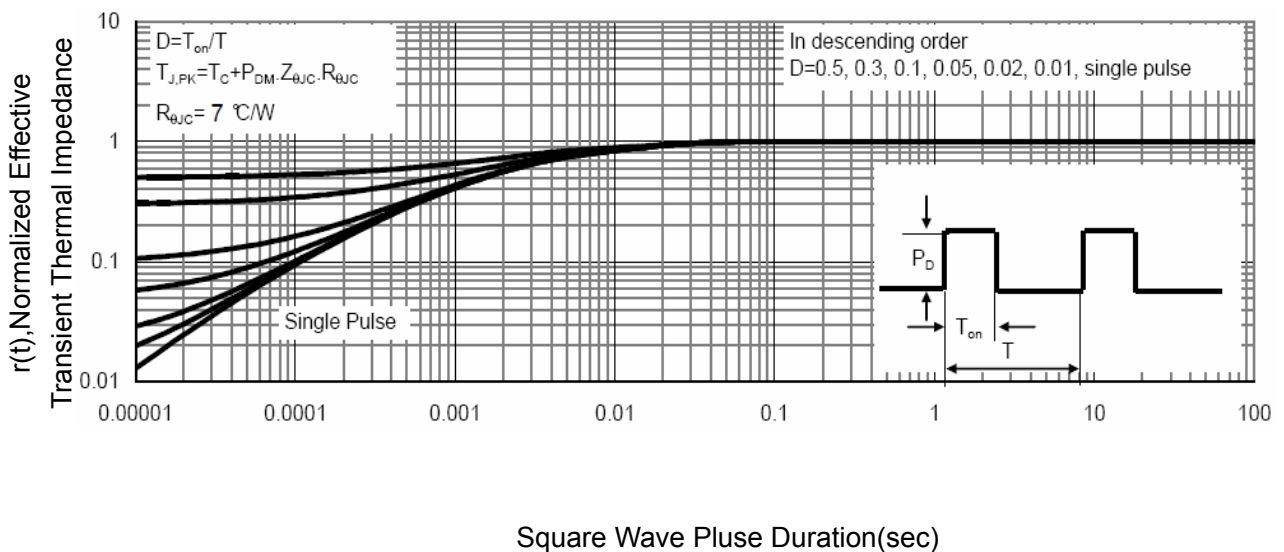

Figure 11 Normalized Maximum Transient Thermal Impedance

**P-Channel Electrical Characteristics (T<sub>C</sub>=25°C unless otherwise noted)**

Parameter	Symbol	Condition	Min	Typ	Max	Unit
<b>Off Characteristics</b>						
Drain-Source Breakdown Voltage	BV <sub>DSS</sub>	V <sub>GS</sub> =0V, I <sub>D</sub> =-250μA	-∞	-	-	V
Zero Gate Voltage Drain Current	I <sub>DSS</sub>	V <sub>DS</sub> =-∞V, V <sub>GS</sub> =0V	-	-	-1	μA
Gate-Body Leakage Current	I <sub>GSS</sub>	V <sub>GS</sub> =±20V, V <sub>DS</sub> =0V	-	-	±100	nA
<b>On Characteristics</b> (Note 3)						
Gate Threshold Voltage	V <sub>GS(th)</sub>	V <sub>DS</sub> =V <sub>GS</sub> , I <sub>D</sub> =-250μA	-0.5	-0.7	-1	V
Drain-Source On-State Resistance	R <sub>DS(on)</sub>	V <sub>GS</sub> =-10V, I <sub>D</sub> =-6A	-	9	12	mΩ
		V <sub>GS</sub> =-4.5V, I <sub>D</sub> =-5A	-	13	16	
Forward Transconductance	g <sub>FS</sub>	V <sub>DS</sub> =-5V, I <sub>D</sub> =-6A	-	15	-	S
<b>Dynamic Characteristics</b> (Note 4)						
Input Capacitance	C <sub>iss</sub>	V <sub>DS</sub> =-∞V, V <sub>GS</sub> =0V, F=1.0MHz	-	920	-	PF
Output Capacitance	C <sub>oss</sub>		-	140	-	PF
Reverse Transfer Capacitance	C <sub>rss</sub>		-	90	-	PF
<b>Switching Characteristics</b> (Note 4)						
Turn-on Delay Time	t <sub>d(on)</sub>	V <sub>DD</sub> =-15V, R <sub>L</sub> =2.5Ω V <sub>GS</sub> =-10V, R <sub>G</sub> =3Ω	-	8	-	nS
Turn-on Rise Time	t <sub>r</sub>		-	30	-	nS
Turn-Off Delay Time	t <sub>d(off)</sub>		-	22	-	nS
Turn-Off Fall Time	t <sub>f</sub>		-	26	-	nS
Total Gate Charge	Q <sub>g</sub>	V <sub>DS</sub> =-15V, I <sub>D</sub> =-6A, V <sub>GS</sub> =-10V	-	16.2	-	nC
Gate-Source Charge	Q <sub>gs</sub>		-	2.9	-	nC
Gate-Drain Charge	Q <sub>gd</sub>		-	3.6	-	nC
<b>Drain-Source Diode Characteristics</b>						
Diode Forward Voltage (Note 3)	V <sub>SD</sub>	V <sub>GS</sub> =0V, I <sub>S</sub> =-6A	-	-	-1.2	V
Diode Forward Current (Note 2)	I <sub>S</sub>		-	-	-35	A
Reverse Recovery Time	t <sub>rr</sub>	T <sub>J</sub> = 25°C, I <sub>F</sub> = -6A di/dt = 100A/μs (Note 3)	-	23	-	nS
Reverse Recovery Charge	Q <sub>rr</sub>		-	14	-	nC

P-Channel Typical Electrical and Thermal Characteristics (Curves)

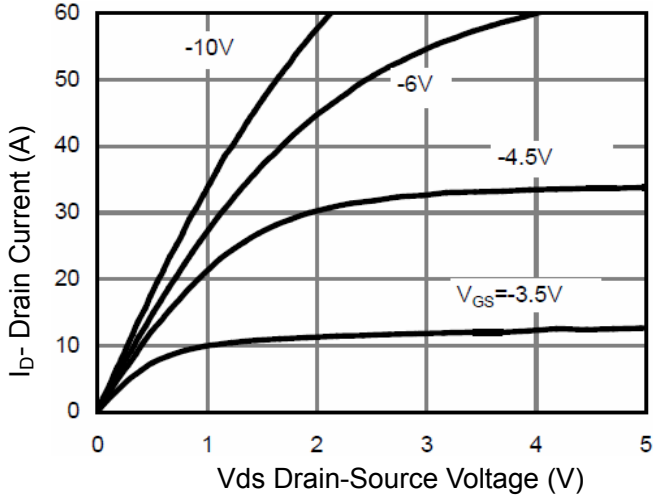

Figure 1 Output Characteristics

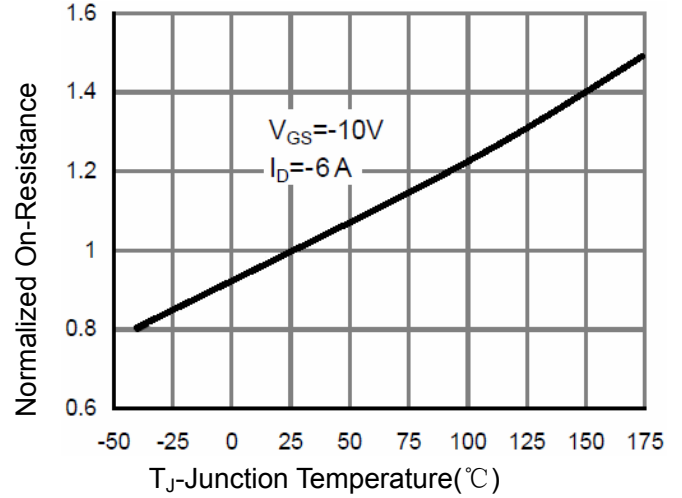

Figure 4 Rdson-Junction Temperature

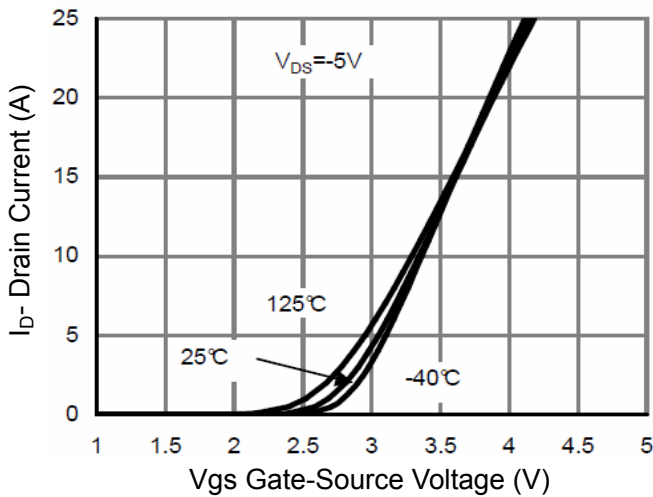

Figure 2 Transfer Characteristics

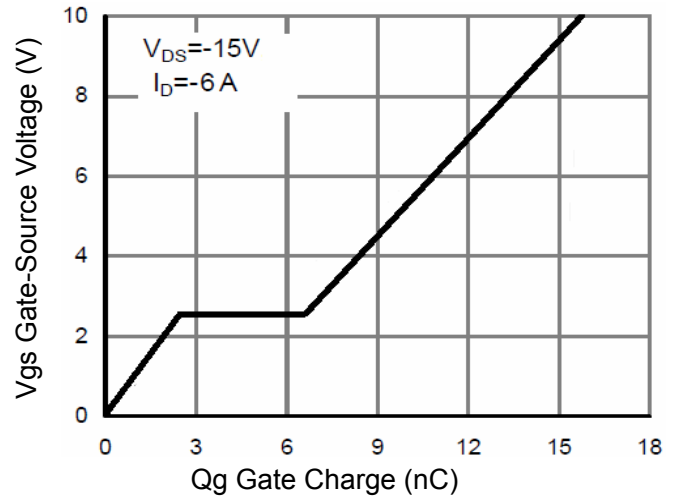

Figure 5 Gate Charge

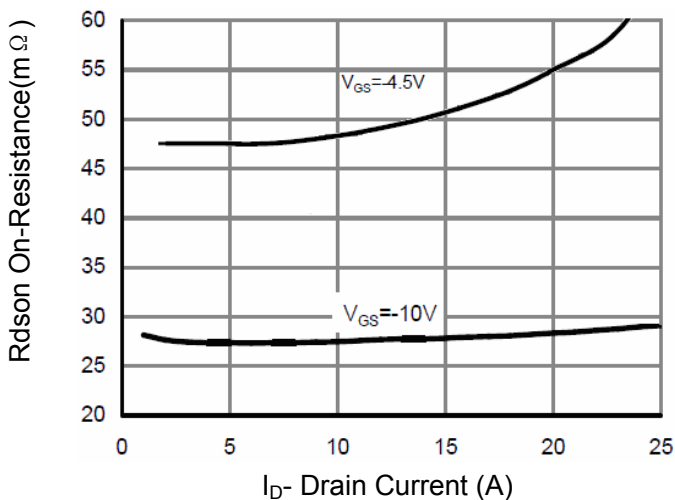

Figure 3 Rdson- Drain Current

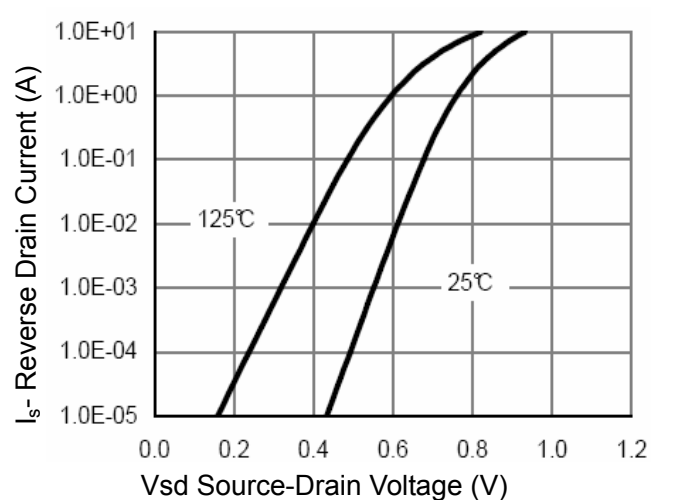

Figure 6 Source- Drain Diode Forward

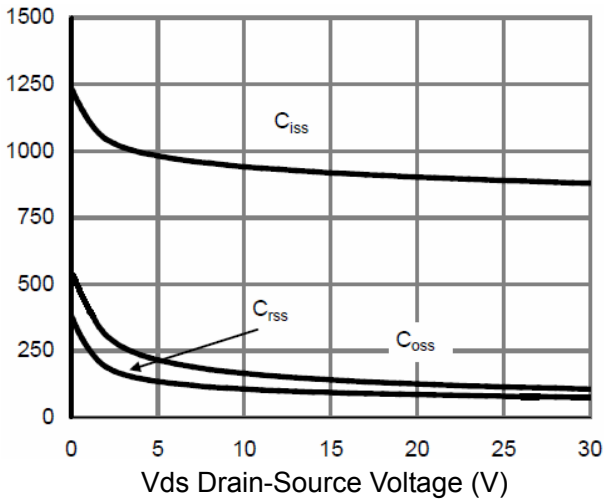

Figure 7 Capacitance vs Vds

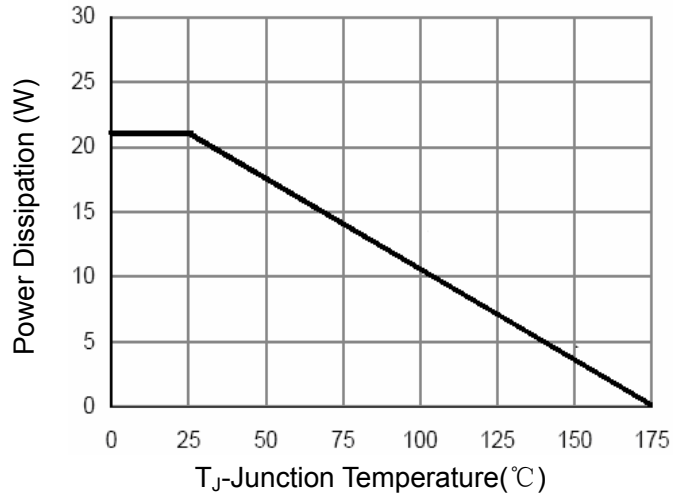

Figure 9 Power De-rating

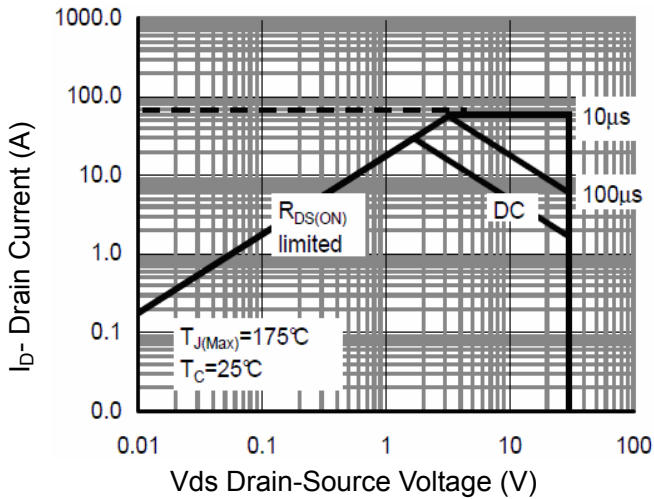

Figure 8 Safe Operation Area

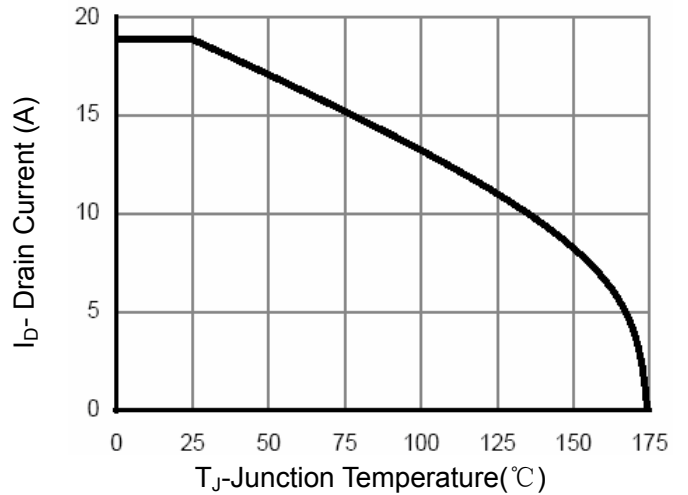

Figure 10 Current De-rating

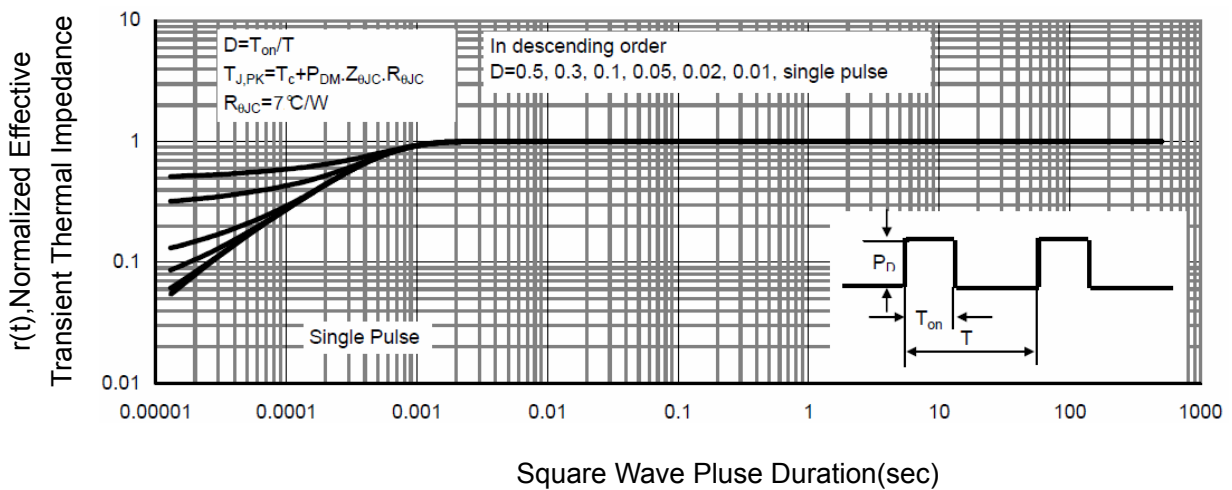
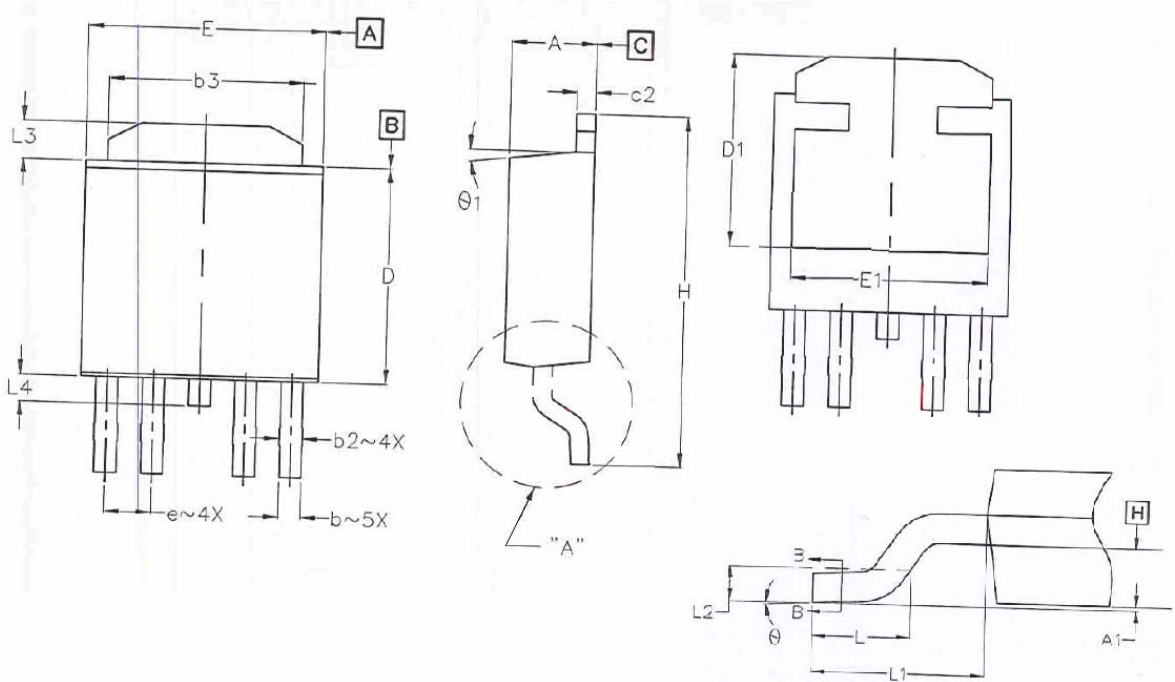

Figure 11 Normalized Maximum Transient Thermal Impedance

TO-252-4L Package Information



Symbol	Dimensions In Millimeters		Dimensions In Inches	
	Min.	Max.	Min.	Max.
A	2.184	2.387	0.086	0.094
A1	-	0.127	-	0.094
b	0.508	0.711	0.020	0.028
b1	0.508	0.660	0.020	0.026
b2	0.610	0.787	0.024	0.031
b3	4.953	5.461	0.195	0.215
c	0.460	0.610	0.018	0.024
c1	0.410	0.559	0.016	0.022
C2	0.460	12.950	0.498	0.510
D	4.980	5.180	0.196	0.204
D1	2.650	2.950	0.104	0.116
E	7.900	8.100	0.311	0.319
E1	0.000	0.300	0.000	0.012
e	12.900	13.400	0.508	0.528
H	2.850	3.250	0.112	0.128
L	1.397	1.778	0.055	0.070
L1	2.743	BSC	0.108	BSC
L2	0.508	BSC	0.020	BSC
L3	0.889	1.270	0.035	0.050
L4	-	1.015	-	0.040
theta	0°	10°	0°	10°
theta 1	0°	15°	0°	15°